

# CABLE ASSEMBLY SCHEMES

## for *North Input* cabling

### Change History

<b>Version</b>	<b>Date</b>	<b>Changes/Reasons</b>	<b>Authors</b>
<b>v1</b>	2000	initial suspension cabling	Ceccanti, Dattilo
<b>v2</b>	2003	added cabling of sensors and actuators on Filter #7	Dattilo, Nenci
<b>v3r0</b>	4mar08	added TCS cabling	Berni, Dattilo, Gherardini
<b>v3r1</b>	22feb10	Added 2 temperature sensors close to the RefMass	Dattilo, Gherardini
<b>v4r0</b>	dec 2014	Modified cabling for allow new separating roof and new payload (cables F,R,S,U,V) and new F#7 actuation/sensing system (T, W, Z). Pre-existing cables U, X and Z suppressed. No more tiltmeters on F#7, more devices on payload.	Berni, Dattilo, Gherardini
<b>v4r1</b>	07apr2015	Added cable P for LVDTs and and Q for Piezos on IP feet; Change in cable U (now different with respect the one of WI)	Berni, Dattilo

### **Table of Contents**

<b>INFORMAZIONI GENERALI .....</b>	<b>3</b>
<b>Identificazione componenti.....</b>	<b>3</b>
<b>Legenda .....</b>	<b>4</b>
<b>LEMO pinout of the main devices .....</b>	<b>4</b>
<b>CABLE A (VACUUM SIDE) .....</b>	<b>5</b>
<b>CABLE B (VACUUM SIDE) .....</b>	<b>6</b>
<b>CABLE C (VACUUM SIDE) .....</b>	<b>7</b>
<b>CABLE D (VACUUM SIDE) .....</b>	<b>8</b>
<b>CABLE E (VACUUM SIDE).....</b>	<b>9</b>
<b>CABLE F (VACUUM SIDE).....</b>	<b>10</b>
<b>CABLE G (VACUUM SIDE) .....</b>	<b>11</b>
<b>CABLE H (VACUUM SIDE) .....</b>	<b>12</b>
<b>CABLE J (VACUUM SIDE).....</b>	<b>13</b>
<b>CABLE K (VACUUM SIDE) .....</b>	<b>14</b>
<b>CABLE L (VACUUM SIDE).....</b>	<b>15</b>
<b>CABLE M (VACUUM SIDE).....</b>	<b>16</b>
<b>CABLE N (VACUUM SIDE) .....</b>	<b>17</b>
<b>CABLE O (VACUUM SIDE) .....</b>	<b>18</b>
<b>CABLE P (VACUUM SIDE).....</b>	<b>19</b>
<b>CABLE Q (VACUUM SIDE).....</b>	<b>20</b>

<b>CABLE R (VACUUM SIDE)</b> .....	<b>21</b>
<b>CABLE S (VACUUM SIDE)</b> .....	<b>22</b>
<b>CABLE T (VACUUM SIDE)</b> .....	<b>23</b>
<b>CABLE U (VACUUM SIDE)</b> .....	<b>24</b>
<b>CABLE V (VACUUM SIDE)</b> .....	<b>25</b>
<b>CABLE X (VACUUM SIDE)</b> .....	<b>26</b>
<b>CABLE W (VACUUM SIDE)</b> .....	<b>27</b>
<b>CABLE Z (VACUUM SIDE)</b> .....	<b>28</b>

## **Informazioni generali**

Ciascun spezzone di cavo va terminato ad una estremità da un connettore circolare 32 poli (tipo presa), all'altra estremità con uno o più connettori Lemo multipolari (generalmente tipo spina). I cavi sono del tipo:

- cavo piatto a 18 o 20 conduttori trefolati AWG 24, isolati in goretex, a coppie ritorte e schermate singolarmente (cavo STP).
- cavo assemblato in lab a conduttori solidi AWG 18, isolati in polimide, a coppie ritorte (cavo TP).
- cavo assemblato in lab a conduttori solidi AWG 22, isolati in polimide, a triplette ritorte (cavo TT).

## **Identificazione componenti**

- Ciascun cavo è identificato da una lettera dell'alfabeto.
- Il tipo di cavo utilizzato e' indicato in prossimità del disegno: la sigla comprende il numero di coppie di conduttori, il tipo di schermatura (STP, TP, TT), la sezione (es. AWG24). Es.: la sigla **9.STP.AWG24** specifica un tipo di cavo avente 18 conduttori intrecciati e schermati a coppie, di sezione AWG24
- Ciascun conduttore di un cavo STP è identificato da un numero cardinale relativo alla coppia (**1** per la coppia bianco/rossa a seguire fino ad **9** per le altre coppie bianco/gialle), da una lettera (**A** per il conduttore con isolante a strisce rosse, **B** per l'altro conduttore della coppia, **S** per la calza) (es. la calza nella terza coppia, è identificata da **3.S** ).
- Ciascun connettore Lemo è identificato da due caratteri: il primo è la lettera del cavo sul quale è saldato il connettore, il secondo è un numero cardinale, che va da 1 al n. max di connettori Lemo sullo stesso cavo (es. per il cavo **B** terminato da due Lemo, essi sono identificati da **B1** e **B2**)
- I contatti di ciascun connettore Lemo sono identificati dal nome del connettore, seguito dal numero del contatto indicato sull'isolante del connettore (es. il contatto<sup>1</sup> n. 4 che si trova sul connettore Lemo **B3** e' identificato da **B3.4**)
- I contatti di ciascun connettore circolare a 32 poli sono identificati da lettere (A÷Z, a÷j). Per quelli interni vale il pinout serigrafato sul retro dell'isolante, per quo 20elli esterni vale il pinout standard

---

<sup>1</sup> Nel caso di conduttori Lemo, il contatto n. 1 e' quello col semicerchio bianco, i successivi sono quelli lungo la linea bianca che parte dal contatto n. 1.

## Legenda

F1 +	motore, fase 1, positivo
F1 -	motore, fase 1, negativo
F2 +	motore, fase 2, positivo
F2 -	motore, fase 2, negativo
FC cw	motore, fine corsa che si incontra quando l'albero gira in senso orario per un osservatore coincidente con il motore
FC ccw	motore, fine corsa che si incontra quando l'albero gira in senso antiorario per un osservatore coincidente con il motore
FC com	motore, fine corsa, comune
RST up	motore, reostato, terminale superiore
RST down	motore, reostato, terminale inferiore
RST com	motore, reostato, comune o cursore
TP sx +	thermal probe, sinistro, positivo
TP sx -	thermal probe, sinistro, negativo
TP dx +	thermal probe, destro, positivo
TP dx -	thermal probe, destro, negativo
Ls	LVDT, secondario
Lp	LVDT, primario
C +	coil attuatore, positivo
C -	coil attuatore, negativo
fbk	accelerometro, feedback
RH +	Reinh Heater, positivo
RH -	Ring Heater, negativo

## LEMO pinout of the main devices

ACCELEROMETER	
LEMO contacts	Contact descript.
1	Lp
2	Lp
3	
4	F1 +
5	F1 -
6	F2 +
7	F2 -
8	
9	FC cw
11	FC ccw
10	FC com
12	fbk
13	fbk
14	
15	Ls
16	Ls
17	
18	

LVDT	
LEMO contacts	Contact descript.
1	Lp +
2	Lp -
3	Ls +
4	Ls -

COIL	
LEMO contacts	Contact descript.
1	C +
2	C -

MOTOR		
LEMO contacts	Contact descript.	UTG 12p contacts
1	F1 +	A
2	F1 -	B
	F1 shield	C
3	F2 +	D
4	F2 -	E
	F2 shield	F
5	FC cw	G
6	FC ccw	H
7	FC com	J
8	n.c.	

**cable A** (vacuum side)

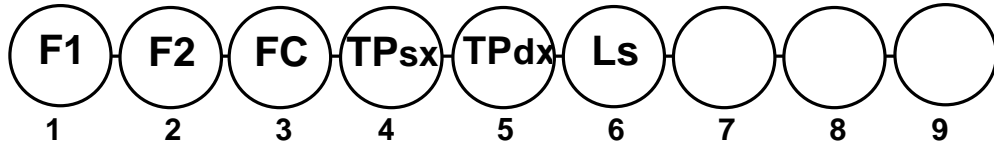
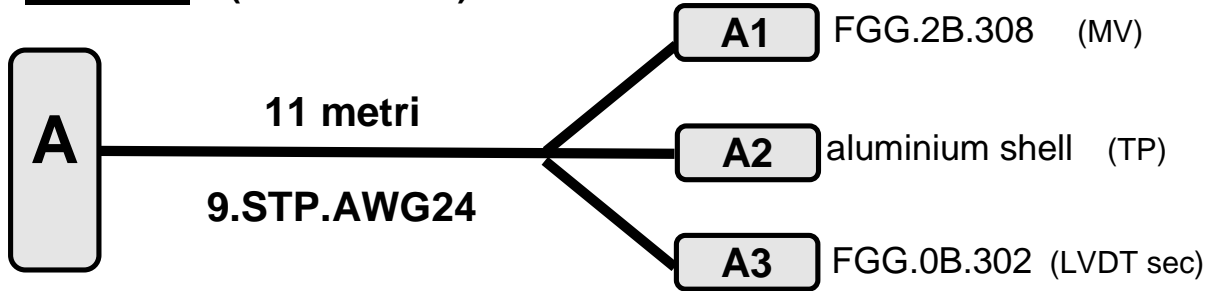

Cutting and Stripping phase
Date:
Operator:
Reel:

Crimping and Labeling phase
Date:
Operator:
Duration (hours):

Quality Control phase
Date:
Operator:

Cleaning and Storage phase
Date:
Operator:

Notes:
Diramare a 60 cm

MIL-32 contacts	conductors	LEMO contacts	contact description
<b>A</b>	1.A	A1.1	F1 +
<b>B</b>	1.B	A1.2	F1 -
<b>C</b>	1.S	n.c.	
<b>D</b>	2.A	A1.3	F2 +
<b>E</b>	2.B	A1.4	F2 -
<b>F</b>	2.S	n.c.	
<b>G</b>	3.A	A1.5	FC cw
<b>H</b>	3.B	A1.6	FC ccw
<b>J</b>	3.S	A1.7	FC com
<b>K</b>	4.A	A2	TP sx +
<b>L</b>	4.B	A2	TP sx -
<b>M</b>	4.S	n.c.	
<b>N</b>	5.A	A2	TP dx +
<b>P</b>	5.B	A2	TP dx -
<b>R</b>	5.S	n.c.	
<b>S</b>	6.A	A3.1	Ls
<b>T</b>	6.B	A3.2	Ls
<b>U</b>	6.S	n.c.	
<b>V</b>	7.A		
<b>W</b>	7.B		
<b>X</b>	7.S		
<b>Y</b>	8.A		
<b>Z</b>	8.B		
<b>a</b>	8.S		
<b>b</b>	9.A		
<b>c</b>	9.B		
<b>d</b>	9.S		

**cable B** (vacuum side)

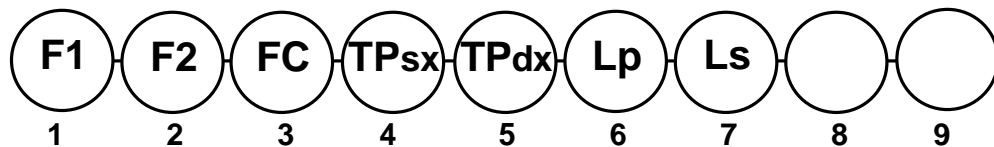
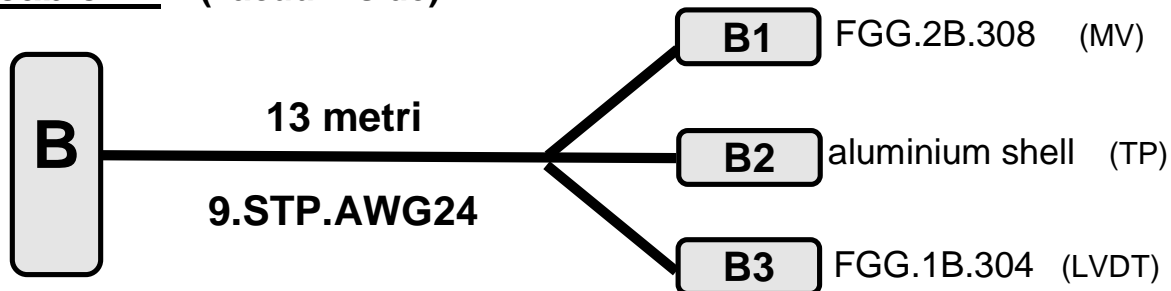

Cutting and Stripping phase
Date:
Operator:
Reel:

Crimping and Labeling phase
Date:
Operator:
Duration (hours):

Quality Control phase
Date:
Operator:

Cleaning and Storage phase
Date:
Operator:

Notes:
Diramare a 60 cm

MIL-32 contacts	conductors	LEMO contacts	contact description
A	1.A	B1.1	F1 +
B	1.B	B1.2	F1 -
C	1.S	n.c.	
D	2.A	B1.3	F2 +
E	2.B	B1.4	F2 -
F	2.S	n.c.	
G	3.A	B1.5	FC cw
H	3.B	B1.6	FC ccw
J	3.S	B1.7	FC com
K	4.A	B2	TP sx +
L	4.B	B2	TP sx -
M	4.S	n.c.	
N	5.A	B2	TP dx +
P	5.B	B2	TP dx -
R	5.S	n.c.	
S	6.A	B3.1	Lp
T	6.B	B3.2	Lp
U	6.S	n.c.	
V	7.A	B3.3	Ls
W	7.B	B3.4	Ls
X	7.S	n.c.	
Y	8.A		
Z	8.B		
a	8.S		
b	9.A		
c	9.B		
d	9.S		

**cable C** (vacuum side)

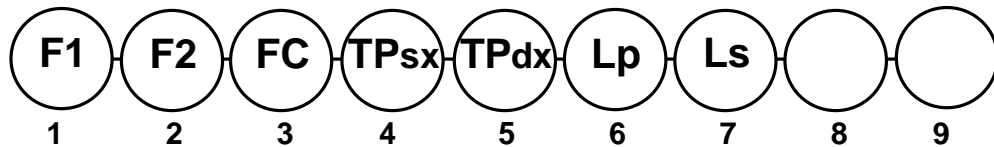
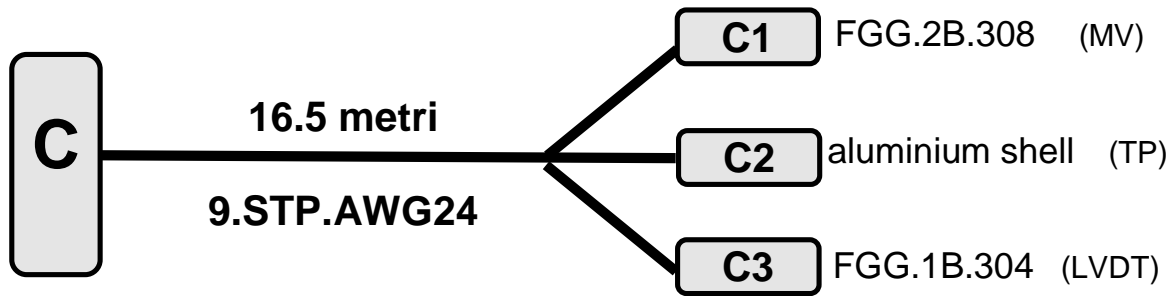

Cutting and Stripping phase
Date:
Operator:
Reel:

Crimping and Labeling phase
Date:
Operator:
Duration (hours):

Quality Control phase
Date:
Operator:

Cleaning and Storage phase
Date:
Operator:

Notes:
Diramare a 60 cm

MIL-32 contacts	conductors	LEMO contacts	contact description
A	1.A	C1.1	F1 +
B	1.B	C1.2	F1 -
C	1.S	n.c.	
D	2.A	C1.3	F2 +
E	2.B	C1.4	F2 -
F	2.S	n.c.	
G	3.A	C1.5	FC cw
H	3.B	C1.6	FC ccw
J	3.S	C1.7	FC com
K	4.A	C2	TP sx +
L	4.B	C2	TP sx -
M	4.S	n.c.	
N	5.A	C2	TP dx +
P	5.B	C2	TP dx -
R	5.S	n.c.	
S	6.A	C3.1	Lp
T	6.B	C3.2	Lp
U	6.S	n.c.	
V	7.A	C3.3	Ls
W	7.B	C3.4	Ls
X	7.S	n.c.	
Y	8.A		
Z	8.B		
a	8.S		
b	9.A		
c	9.B		
d	9.S		

**cable D** (vacuum side)

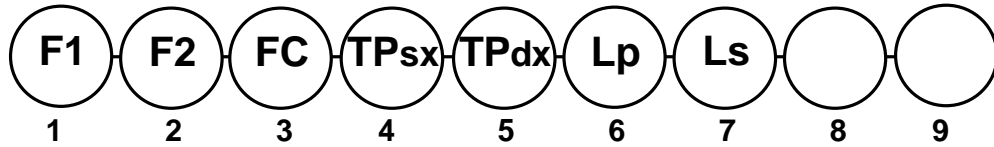
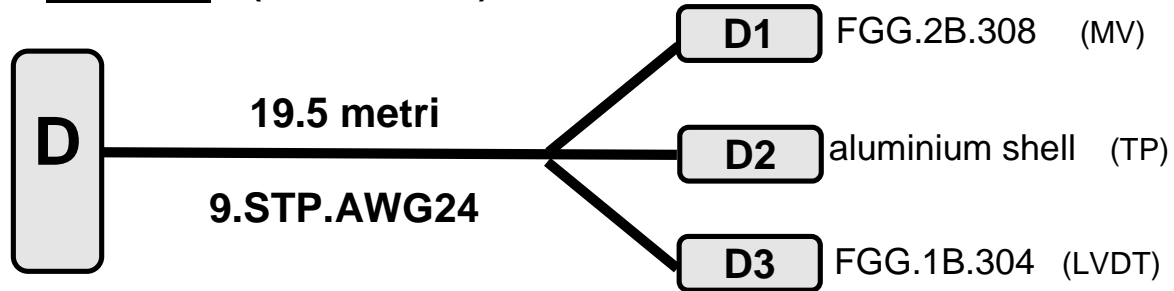

Cutting and Stripping phase
Date:
Operator:
Reel:

Crimping and Labeling phase
Date:
Operator:
Duration (hours):

Quality Control phase
Date:
Operator:

Cleaning and Storage phase
Date:
Operator:

Notes:	7
Diramare a 60 cm	

MIL-32 contacts	conductors	LEMO contacts	contact description
A	1.A	D1.1	F1 +
B	1.B	D1.2	F1 -
C	1.S	n.c.	
D	2.A	D1.3	F2 +
E	2.B	D1.4	F2 -
F	2.S	n.c.	
G	3.A	D1.5	FC cw
H	3.B	D1.6	FC ccw
J	3.S	D1.7	FC com
K	4.A	D2	TP sx +
L	4.B	D2	TP sx -
M	4.S	n.c.	
N	5.A	D2	TP dx +
P	5.B	D2	TP dx -
R	5.S	n.c.	
S	6.A	D3.1	Lp
T	6.B	D3.2	Lp
U	6.S	n.c.	
V	7.A	D3.3	Ls
W	7.B	D3.4	Ls
X	7.S	n.c.	
Y	8.A		
Z	8.B		
a	8.S		
b	9.A		
c	9.B		
d	9.S		



**cable E** (vacuum side)

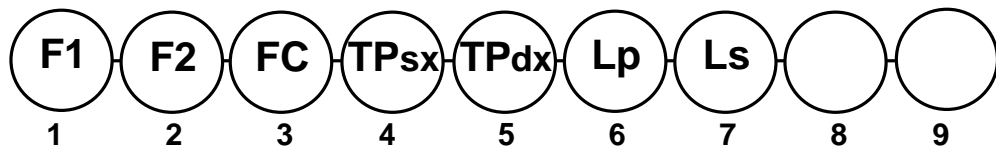
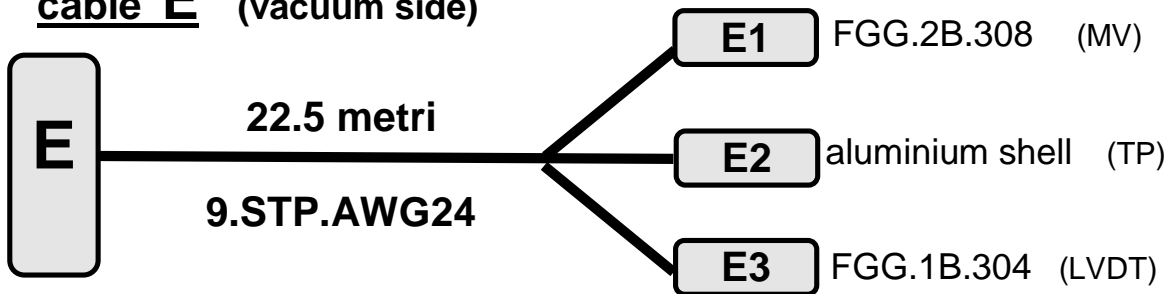

Cutting and Stripping phase
Date:
Operator:
Reel:

Crimping and Labeling phase
Date:
Operator:
Duration (hours):

Quality Control phase
Date:
Operator:

Cleaning and Storage phase
Date:
Operator:

Notes:
Diramare a 60 cm

MIL-32 contacts	conductors	LEMO contacts	contact description
<b>A</b>	1.A	E1.1	F1 +
<b>B</b>	1.B	E1.2	F1 -
<b>C</b>	1.S	n.c.	
<b>D</b>	2.A	E1.3	F2 +
<b>E</b>	2.B	E1.4	F2 -
<b>F</b>	2.S	n.c.	
<b>G</b>	3.A	E1.5	FC cw
<b>H</b>	3.B	E1.6	FC ccw
<b>J</b>	3.S	E1.7	FC com
<b>K</b>	4.A	E2	TP sx +
<b>L</b>	4.B	E2	TP sx -
<b>M</b>	4.S	n.c.	
<b>N</b>	5.A	E2	TP dx +
<b>P</b>	5.B	E2	TP dx -
<b>R</b>	5.S	n.c.	
<b>S</b>	6.A	E3.1	Lp
<b>T</b>	6.B	E3.2	Lp
<b>U</b>	6.S	n.c.	
<b>V</b>	7.A	E3.3	Ls
<b>W</b>	7.B	E3.4	Ls
<b>X</b>	7.S	n.c.	
<b>Y</b>	8.A		
<b>Z</b>	8.B		
<b>a</b>	8.S		
<b>b</b>	9.A		
<b>c</b>	9.B		
<b>d</b>	9.S		

**cable F** (vacuum side)

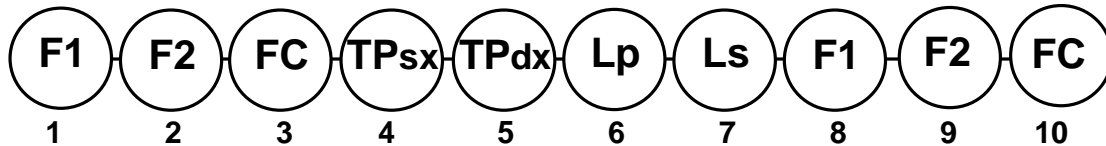
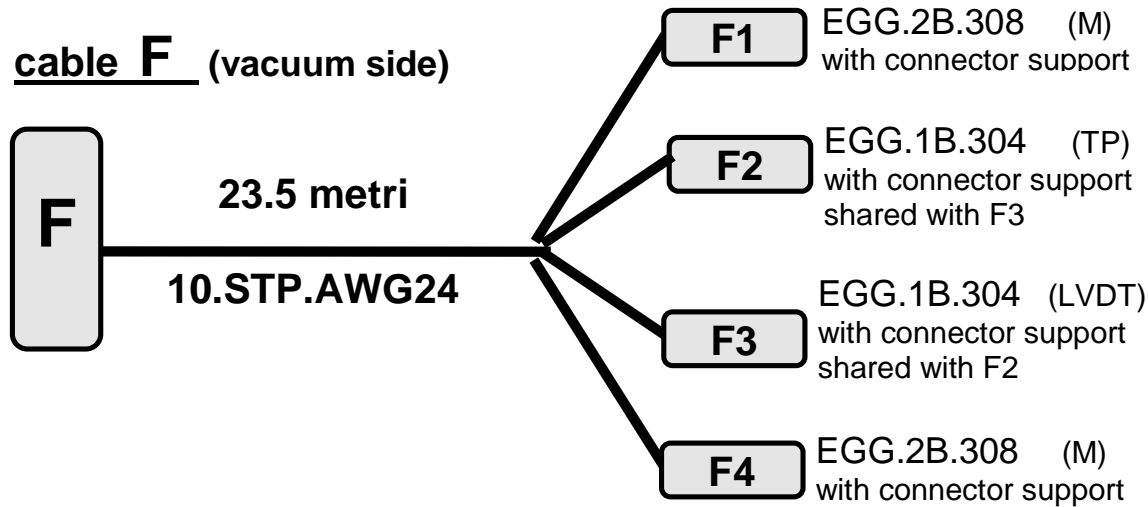

Cutting and Stripping phase
Date:
Operator:
Reel:

Crimping and Labeling phase
Date:
Operator:
Duration (hours):

Quality Control phase
Date:
Operator:

Cleaning and Storage phase
Date:
Operator:

Notes:
Rifatto ex-novo a dicembre 2014. Per lo schema del vecchio cavo F vedere la versione v3.
<b>NB:</b> inserire il lemo da pannello nell'apposito clamp a C.
Diramare a 30 cm
Connectors F2 and F3 share the same connector support.

MIL-32 contacts	conductors	LEMO contacts	contact description
A	1.A	F1.1	F1 +
B	1.B	F1.2	F1 -
C	1.S	n.c.	
D	2.A	F1.3	F2 +
E	2.B	F1.4	F2 -
F	2.S	n.c.	
G	3.A	F1.5	FC cw
H	3.B	F1.6	FC ccw
J	3.S	F1.7	FC com
K	4.A	F2.1	TP sx +
L	4.B	F2.2	TP sx -
M	4.S	n.c.	
N	5.A	F2.3	TP dx +
P	5.B	F2.4	TP dx -
R	5.S	n.c.	
S	6.A	F3.1	Lp
T	6.B	F3.2	Lp
U	6.S	n.c.	
V	7.A	F3.3	Ls
W	7.B	F3.4	Ls
X	7.S	n.c.	
Y	8.A	F4.1	F1 +
Z	8.B	F4.2	F1 -
a	8.S	n.c.	
b	9.A	F4.3	F2 +
c	9.B	F4.4	F2 -
d	9.S	n.c.	
e	10.A	F4.5	FC sx
f	10.B	F4.6	FC dx
g	10.S	F4.7	FC com

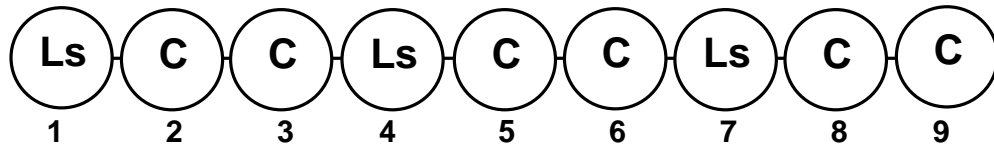
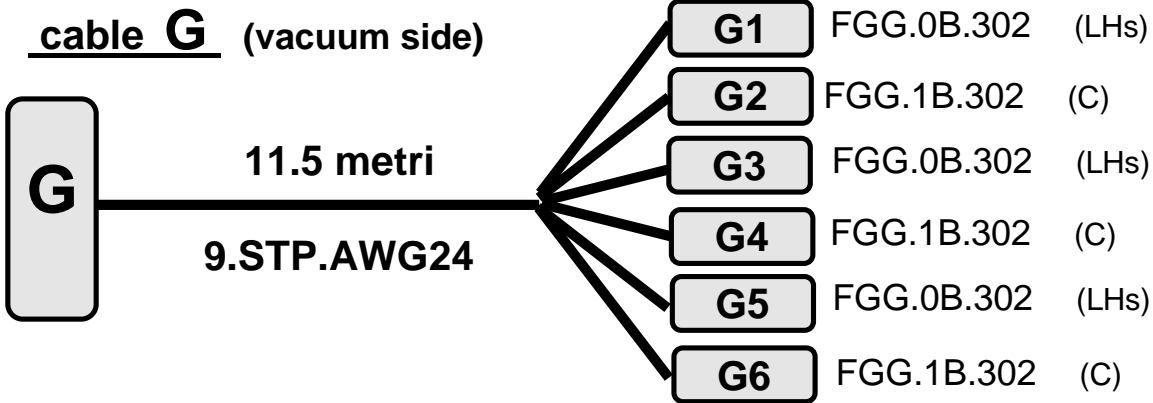

Cutting and Stripping phase
Date:
Operator:
Reel:

Crimping and Labeling phase
Date:
Operator:
Duration (hours):

Quality Control phase
Date:
Operator:

Cleaning and Storage phase
Date:
Operator:

**Notes:**  
 Diramare a gruppi (G1+G2, G3+G4, G5+G6) di 2.5 metri;  
 Scorciare G3+G4 di 1.5 metri rispetto ai 11.5 metri totali;  
 Ponticelli su MIL-32.

MIL-32 contacts	conductors	LEMO contacts	contact description
A	1.A	G1.1	Ls
B	1.B	G1.2	Ls
C	1.S	n.c.	
D	2.A	G2.1	C +
E	2.B	G2.2	C -
F	2.S	n.c.	
G	3.A	G2.1	C +
H	3.B	G2.2	C -
J	3.S	n.c.	
K	4.A	G3.1	Ls
L	4.B	G3.2	Ls
M	4.S	n.c.	
N	5.A	G4.1	C +
P	5.B	G4.2	C -
R	5.S	n.c.	
S	6.A	G4.1	C +
T	6.B	G4.2	C -
U	6.S	n.c.	
V	7.A	G5.1	Ls
W	7.B	G5.2	Ls
X	7.S	n.c.	
Y	8.A	G6.1	C +
Z	8.B	G6.2	C -
a	8.S	n.c.	
b	9.A	G6.1	C +
c	9.B	G6.2	C -
d	9.S	n.c.	

**cable H** (vacuum side)

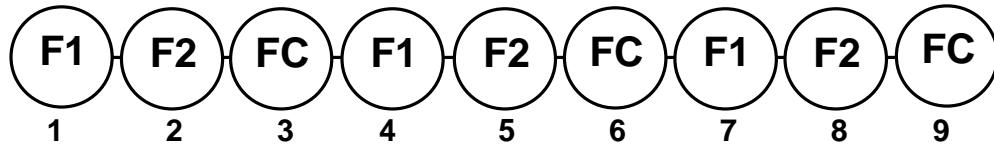
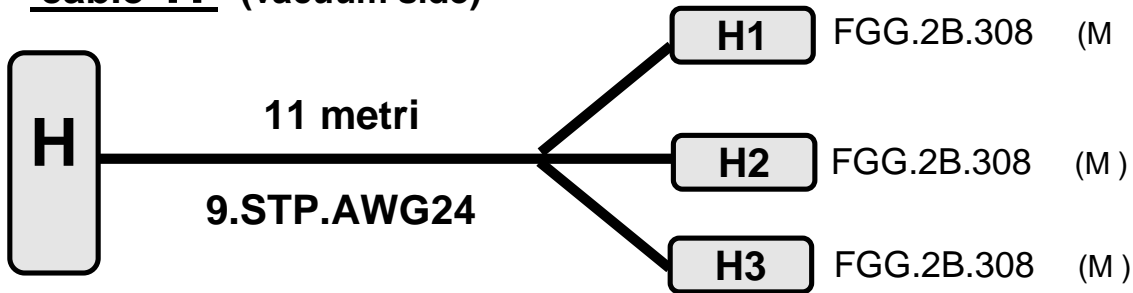

Cutting and Stripping phase
Date:
Operator:
Reel:

Crimping and Labeling phase
Date:
Operator:
Duration (hours):

Quality Control phase
Date:
Operator:

Cleaning and Storage phase
Date:
Operator:

**Notes:**  
 Diramare di 2,5 metri;  
 Scorciare H2 di 1.5 metri.

MIL-32 contacts	conductors	LEMO contacts	contact description
A	1.A	H1.1	F1 +
B	1.B	H1.2	F1 -
C	1.S	n.c.	
D	2.A	H1.3	F2 +
E	2.B	H1.4	F2 -
F	2.S	n.c.	
G	3.A	H1.5	FC cw
H	3.B	H1.6	FC ccw
J	3.S	H1.7	FC com
K	4.A	H2.1	F1 +
L	4.B	H2.2	F1 -
M	4.S	n.c.	
N	5.A	H2.3	F2 +
P	5.B	H2.4	F2 -
H	5.S	n.c.	
S	6.A	H2.5	FC cw
T	6.B	H2.6	FC ccw
U	6.S	H2.7	FC com
V	7.A	H3.1	F1 +
W	7.B	H3.2	F1 -
X	7.S	n.c.	
Y	8.A	H3.3	F2 +
Z	8.B	H3.4	F2 -
a	8.S	n.c.	
b	9.A	H3.5	FC cw
c	9.B	H3.6	FC ccw
d	9.S	H3.7	FC com

**cable J** (vacuum side)

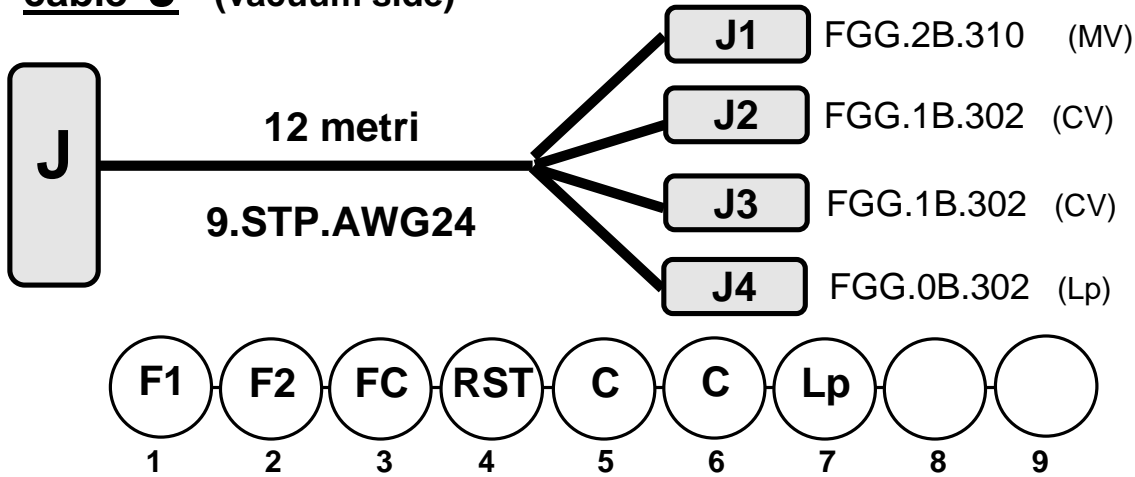

Cutting and Stripping phase	
Date:	
Operator:	
Reel:	

Crimping and Labeling phase	
Date:	
Operator:	
Duration (hours):	

Quality Control phase	
Date:	
Operator:	

Cleaning and Storage phase	
Date:	
Operator:	

**Notes:**  
 Diramare a 100 cm tra J2 e J3;  
 Diramare J3 e J4 di 25 cm;  
 Scorciare J1 di 100 cm;  
 Scorciare J2 di 20 cm.

RST e' il reostato, usato come sensore di posizione dell'hoist.

MIL-32 contacts	conductors	LEMO contacts	contact description
A	1.A	J1.1	F1 +
B	1.B	J1.2	F1 -
C	1.S	n.c.	
D	2.A	J1.3	F2 +
E	2.B	J1.4	F2 -
F	2.S	n.c.	
G	3.A	J1.5	FC cw
H	3.B	J1.6	FC ccw
J	3.S	J1.7	FC com
K	4.A	J1.8	RST down
L	4.B	J1.9	RST up
M	4.S	J1.10	RST com
N	5.A	J2.1	C+
P	5.B	J2.2	C-
R	5.S	n.c.	
S	6.A	J3.1	C+
T	6.B	J3.2	C-
U	6.S	n.c.	
V	7.A	J4.1	Lp
W	7.B	J4.2	Lp
X	7.S	n.c.	
Y	8.A		
Z	8.B		
a	8.S		
b	9.A		
c	9.B		
d	9.S		

**cable K** (vacuum side)

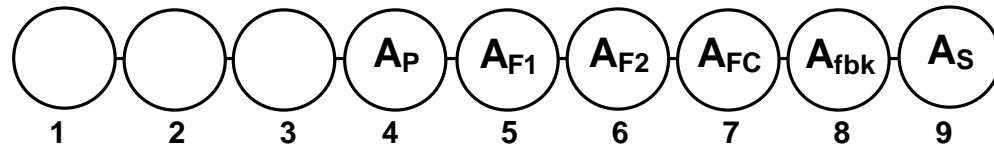
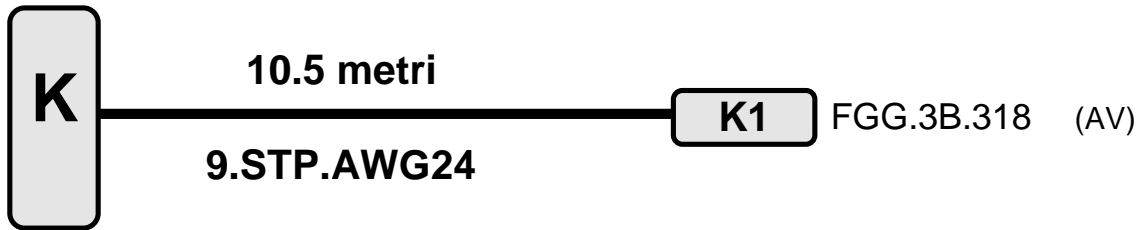

Cutting and Stripping phase
Date:
Operator:
Reel:

Crimping and Labeling phase
Date:
Operator:
Duration (hours):

Quality Control phase
Date:
Operator:

Cleaning and Storage phase
Date:
Operator:

Notes:

MIL-32 contacts	conductors	LEMO contacts	contact description
A	1.A		
B	1.B		
C	1.S		
D	2.A		
E	2.B		
F	2.S		
G	3.A		
H	3.B		
J	3.S		
K	4.A	K1.1	Lp
L	4.B	K1.2	Lp
M	4.S	K1.3	
N	5.A	K1.4	F1 +
P	5.B	K1.5	F1 -
R	5.S	K1.8	
S	6.A	K1.6	F2 +
T	6.B	K1.7	F2 -
U	6.S	K1.18	
V	7.A	K1.9	FC sx
W	7.B	K1.11	FC dx
X	7.S	K1.10	FC com
Y	8.A	K1.12	fbk
Z	8.B	K1.13	fbk
a	8.S	K1.14	
b	9.A	K1.15	Ls
c	9.B	K1.16	Ls
d	9.S	K1.17	

**cable L** (vacuum side)

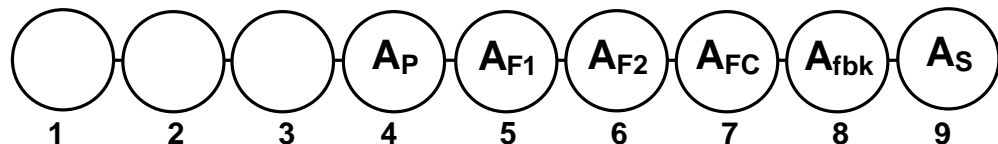
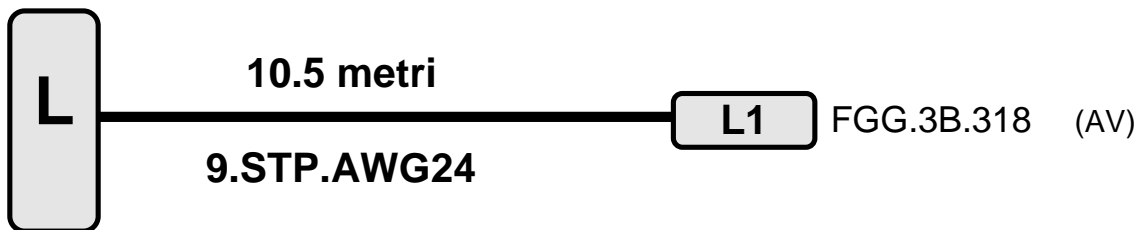

Cutting and Stripping phase
Date:
Operator:
Reel:

Crimping and Labeling phase
Date:
Operator:
Duration (hours):

Quality Control phase
Date:
Operator:

Cleaning and Storage phase
Date:
Operator:

Notes:

MIL-32 contacts	conductors	LEMO contacts	contact description	
A	1.A			
B	1.B			
C	1.S			
D	2.A			
E	2.B			
F	2.S			
G	3.A			
H	3.B			
J	3.S			
K	4.A	L1.1	Lp	1
L	4.B	L1.2	Lp	2
M	4.S	L1.3		3
N	5.A	L1.4	F1 +	
P	5.B	L1.5	F1 -	
R	5.S	L1.8		
S	6.A	L1.6	F2 +	
T	6.B	L1.7	F2 -	
U	6.S	L1.18		
V	7.A	L1.9	FC sx	
W	7.B	L1.11	FC dx	
X	7.S	L1.10	FC com	
Y	8.A	L1.12	fbk	4
Z	8.B	L1.13	fbk	5
a	8.S	L1.14		6
b	9.A	L1.15	Ls	7
c	9.B	L1.16	Ls	8
d	9.S	L1.17		9

**cable M (vacuum side)**

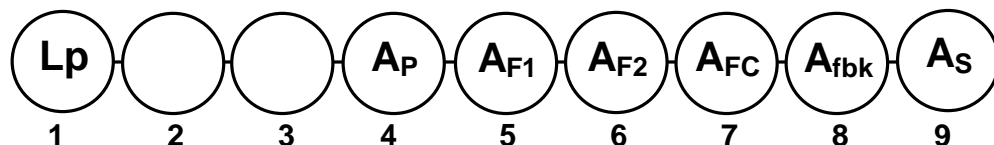
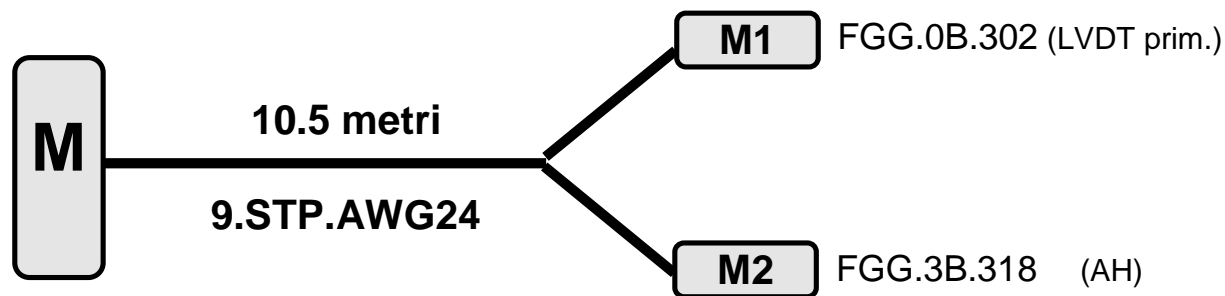

Cutting and Stripping phase
Date:
Operator:
Reel:

Crimping and Labeling phase
Date:
Operator:
Duration (hours):

Quality Control phase
Date:
Operator:

Cleaning and Storage phase
Date:
Operator:

Notes:
Diramare a 60 cm

MIL-32 contacts	conductors	LEMO contacts	contact description
A	1.A	M1.1	Lp
B	1.B	M1.2	Lp
C	1.S	n.c.	
D	2.A		
E	2.B		
F	2.S		
G	3.A		
H	3.B		
J	3.S		
K	4.A	M2.1	Lp
L	4.B	M2.2	Lp
M	4.S	M2.3	
N	5.A	M2.4	F1 +
P	5.B	M2.5	F1 -
R	5.S	M2.8	
S	6.A	M2.6	F2 +
T	6.B	M2.7	F2 -
U	6.S	M2.18	
V	7.A	M2.9	FC sx
W	7.B	M2.11	FC dx
X	7.S	M2.10	FC com
Y	8.A	M2.12	fbk
Z	8.B	M2.13	fbk
a	8.S	M2.14	
b	9.A	M2.15	Ls
c	9.B	M2.16	Ls
d	9.S	M2.17	



**cable N** (vacuum side)

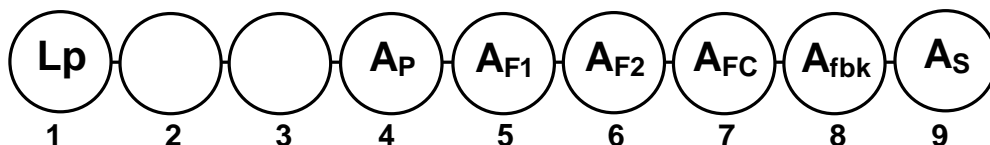
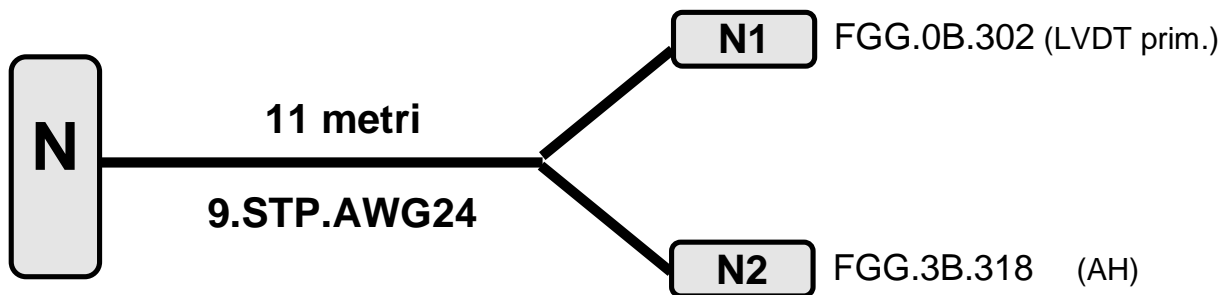

Cutting and Stripping phase
Date:
Operator:
Reel:

Crimping and Labeling phase
Date:
Operator:
Duration (hours):

Quality Control phase
Date:
Operator:

Cleaning and Storage phase
Date:
Operator:

Notes:
Diramare a 60 cm

MIL-32 contacts	conductors	LEMO contacts	contact description	
A	1.A	N1.1	Lp	1
B	1.B	N1.2	Lp	2
C	1.S	n.c.		3
D	2.A			
E	2.B			
F	2.S			
G	3.A			
H	3.B			
J	3.S			
K	4.A	N2.1	Lp	1
L	4.B	N2.2	Lp	2
M	4.S	N2.3		3
N	5.A	N2.4	F1 +	
P	5.B	N2.5	F1 -	
R	5.S	N2.8		
S	6.A	N2.6	F2 +	
T	6.B	N2.7	F2 -	
U	6.S	N2.18		
V	7.A	N2.9	FC sx	
W	7.B	N2.11	FC dx	
X	7.S	N2.10	FC com	
Y	8.A	N2.12	fbk	4
Z	8.B	N2.13	fbk	5
a	8.S	N2.14		6
b	9.A	N2.15	Ls	7
c	9.B	N2.16	Ls	8
d	9.S	N2.17		9

**cable O (vacuum side)**

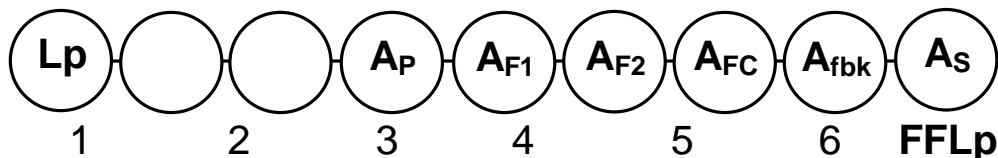
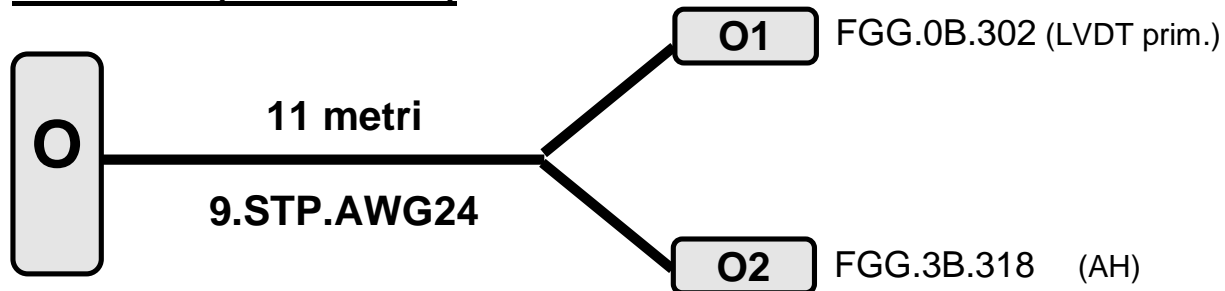

Cutting and Stripping phase
Date:
Operator:
Reel:

Crimping and Labeling phase
Date:
Operator:
Duration (hours):

Quality Control phase
Date:
Operator:

Cleaning and Storage phase
Date:
Operator:

Notes:
Diramare a 60 cm

MIL-32 contacts	conductors	LEMO contacts	contact description
<b>A</b>	1.A	O1.1	Lp
<b>B</b>	1.B	O1.2	Lp
<b>C</b>	1.S	n.c.	
<b>D</b>	2.A		
<b>E</b>	2.B		
<b>F</b>	2.S		
<b>G</b>	3.A		
<b>H</b>	3.B		
<b>J</b>	3.S		
<b>K</b>	4.A	O2.1	Lp
<b>L</b>	4.B	O2.2	Lp
<b>M</b>	4.S	O2.3	
<b>N</b>	5.A	O2.4	F1 +
<b>P</b>	5.B	O2.5	F1 -
<b>R</b>	5.S	O2.8	
<b>S</b>	6.A	O2.6	F2 +
<b>T</b>	6.B	O2.7	F2 -
<b>U</b>	6.S	O2.18	
<b>V</b>	7.A	O2.9	FC sx
<b>W</b>	7.B	O2.11	FC dx
<b>X</b>	7.S	O2.10	FC com
<b>Y</b>	8.A	O2.12	fbk
<b>Z</b>	8.B	O2.13	fbk
<b>a</b>	8.S	O2.14	
<b>b</b>	9.A	O2.15	Ls
<b>c</b>	9.B	O2.16	Ls
<b>d</b>	9.S	O2.17	

**Cable P** (vacuum side)

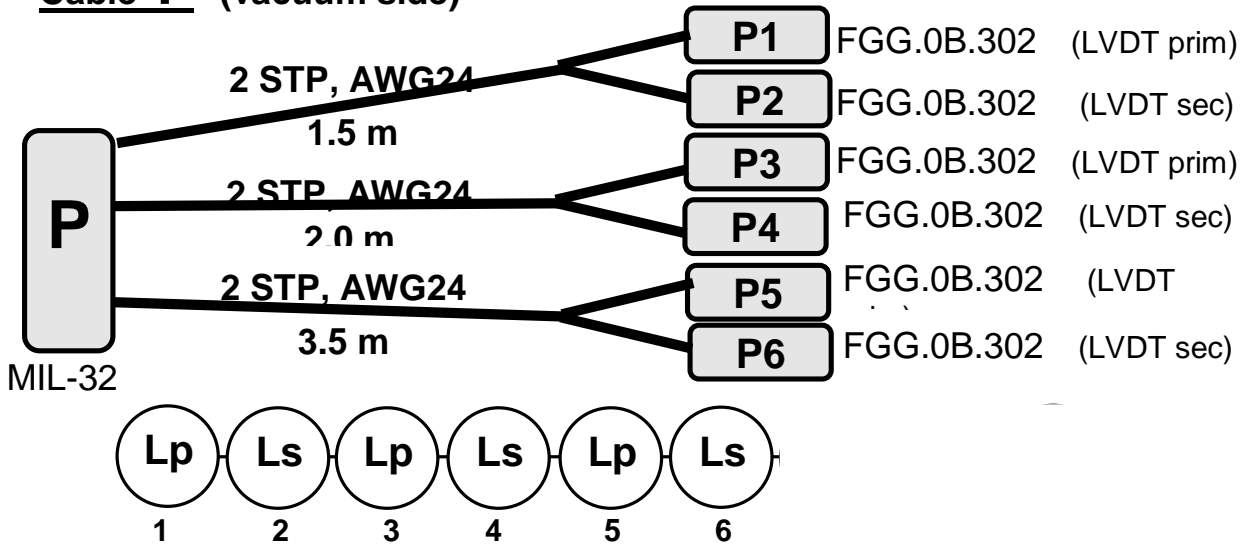

MIL-32 contacts	conductors	LEMO contacts	contact description
A	1.A	P1.1	Lp
B	1.B	P1.2	Lp
C	1.S	n.c.	
D	2.A	P2.3	Ls
E	2.B	P2.4	Ls
F	2.S	n.c.	
G	3.A	P3.5	Lp
H	3.B	P3.6	Lp
J	3.S	n.c.	
K	4.A	P4.7	Ls
L	4.B	P4.8	Ls
M	4.S	n.c.	
N	5.A	P5.1	Lp
P	5.B	P5.2	Lp
R	5.S	n.c.	
S	6.A	P6.1	Ls
T	6.B	P6.2	Ls
U	6.S	n.c.	

Cutting and Stripping phase
Data:
Operator:
Bobina di provenienza: <i>spezzoni</i>

Crimping and Labeling phase
Data:
Operator:
Tempo impiegato (ore):

Quality Control phase
Date: <i>23 feb 15</i>
Operator: <i>Berni</i>

Cleaning and Storage phase
Data:
Operatore/i:

**Notes:**

Diramare opportunamente, considerando che gli LVDT sono disposti a 120 gradi lungo i piedi dell'IP.

**Cable Q (vacuum side)**

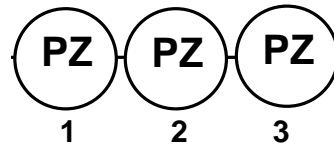
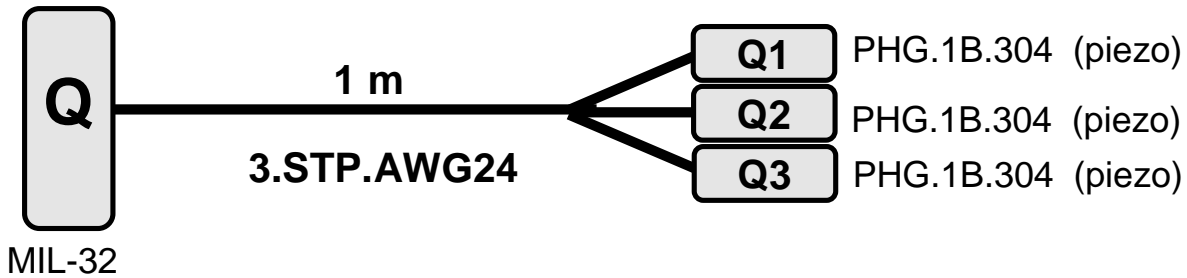

Cutting and Stripping phase
Data:
Operator:
Bobina di provenienza: <i>spezzoni</i>

Crimping and Labeling phase
Data:
Operator:
Tempo impiegato (ore):

Quality Control phase
Date: <i>23 feb 15</i>
Operator: <i>Berni</i>

Cleaning and Storage phase
Data:
Operatore/i:

**Notes:**  
Creato per separare I piezo dagli LVDTs sul cavo P.

MIL-32 contacts	conductors	LEMO contacts	contact description
A			
B			
C			
D			
E			
F			
G			
H			
J			
K			
L			
M			
N			
P			
R			
S			
T			
U			
V	1.A	Q1.1	inner conductor
W	1.B	Q1.2	intermediate shield
X	1.S	Q1.3	outer shield
	n.c.	Q1.4	
Y	2.A	Q2.1	inner conductor
Z	2.B	Q2.2	intermediate shield
a	2.S	Q2.3	outer shield
	n.c.	Q2.4	
b	3.A	Q3.1	inner conductor
c	3.B	Q3.2	intermediate shield
d	3.S	Q3.3	outer shield
	n.c.	Q3.4	

**cable R (vacuum side)**

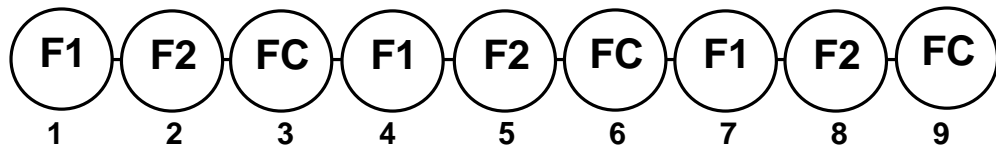
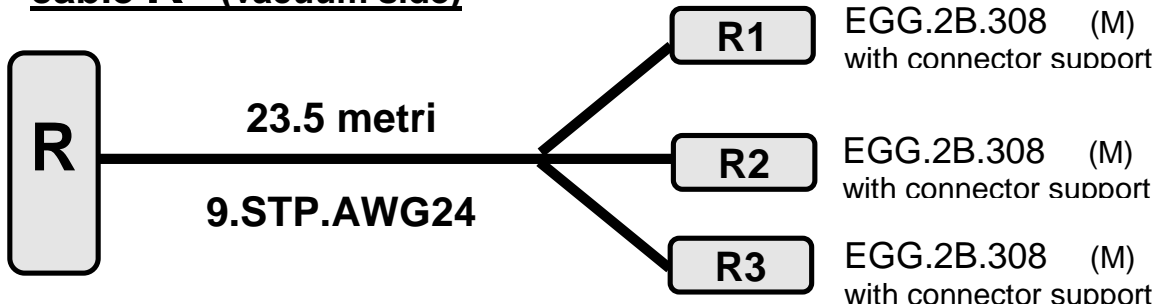

Cutting and Stripping phase
Date:
Operator:
Reel:

Crimping and Labeling phase
Date:
Operator:
Duration (hours):

Quality Control phase
Date:
Operator:

Cleaning and Storage phase
Date:
Operator:

Notes:
Modificato a Dicembre 2014 (scorciato e con Lemo da pannello). Per lo schema del vecchio cavo R vedere la versione v3.
<b>NB:</b> inserire il lemo da pannello nell'apposito clamp a C.
Diramare a <u>20</u> cm

MIL-32 contacts	conductors	LEMO contacts	contact description
A	1.A	R1.1	F1 +
B	1.B	R1.2	F1 -
C	1.S	n.c.	
D	2.A	R1.3	F2 +
E	2.B	R1.4	F2 -
F	2.S	n.c.	
G	3.A	R1.5	FC cw
H	3.B	R1.6	FC ccw
J	3.S	R1.7	FC com
K	4.A	R2.1	F1 +
L	4.B	R2.2	F1 -
M	4.S	n.c.	
N	5.A	R2.3	F2 +
P	5.B	R2.4	F2 -
R	5.S	n.c.	
S	6.A	R2.5	FC cw
T	6.B	R2.6	FC ccw
U	6.S	R2.7	FC com
V	7.A	R3.1	F1 +
W	7.B	R3.2	F1 -
X	7.S	n.c.	
Y	8.A	R3.3	F2 +
Z	8.B	R3.4	F2 -
a	8.S	n.c.	
b	9.A	R3.5	FC cw
c	9.B	R3.6	FC ccw
d	9.S	R3.7	FC com

**cable S (vacuum side)**

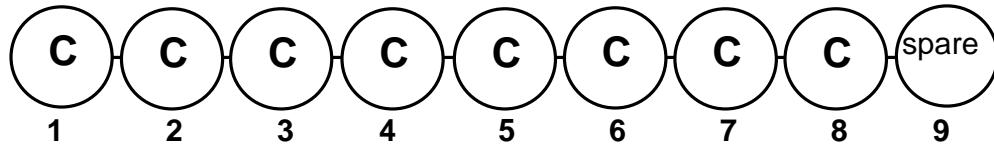
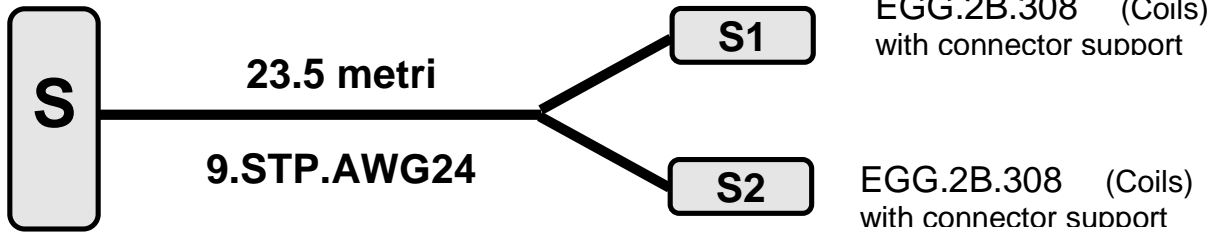

Cutting and Stripping phase
Date:
Operator: <i>Gherardini</i>
Reel: <i>vecchio cavo S</i>

Crimping and Labeling phase
Date:
Operator: <i>Gherardini</i>
Duration (hours):

Quality Control phase
Date:
Operator: <i>Gherardini</i>

Cleaning and Storage phase
Date:
Operator:

Notes:
Modificato ad Aprile 2015 (scorciato, messo Lemo da pannello, <b>tolti ponticelli dal Mil-32</b> , usato vecchio cavo S). Per lo schema del vecchio cavo S vedere la versione v3.
<b>NB:</b> inserire il lemo da pannello nell'apposito clamp a C.
Diramare a <u>20 cm</u> ;

MIL-32 contacts	conductors	LEMO contacts	contact description
A	1.A	S1.1	C +
B	1.B	S1.2	C -
C	1.S	n.c.	
D	2.A	S1.3	C +
E	2.B	S1.4	C -
F	2.S	n.c.	
G	3.A	S1.5	C +
H	3.B	S1.6	C -
J	3.S	n.c.	
K	4.A	S1.7	C +
L	4.B	S1.8	C -
M	4.S	n.c.	
N	5.A	S2.1	C +
P	5.B	S2.2	C -
R	5.S	n.c.	
S	6.A	S2.3	C +
T	6.B	S2.4	C -
U	6.S	n.c.	
V	7.A	S2.5	C +
W	7.B	S2.6	C -
X	7.S	n.c.	
Y	8.A	S2.7	C +
Z	8.B	S2.8	C -
a	8.S	n.c.	
b	9.A		
c	9.B		
d	9.S		

## cable T (vacuum side)

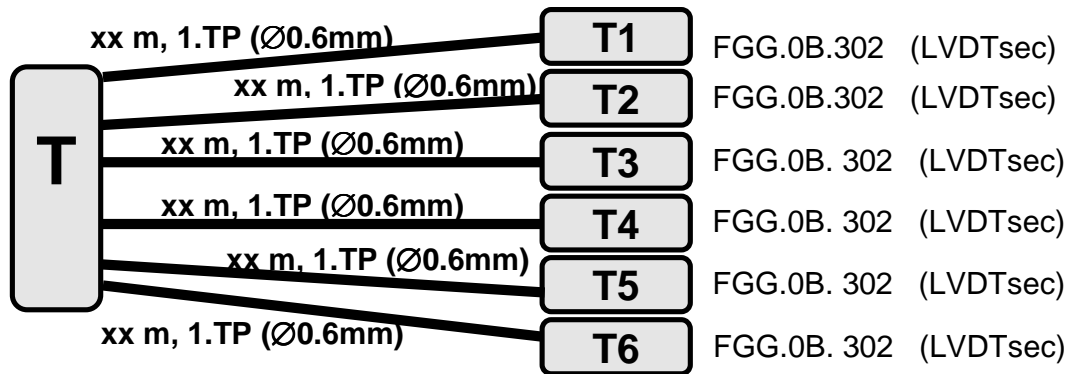

Cutting and Stripping phase
Date:
Operator:
Reel: #xx by MWS, AWG 24 HML

Crimping and Labeling phase
Date:
Operator:
Duration (hours):

Quality Control phase
Date:
Operator:

Cleaning and Storage phase
Date:
Operator:

Notes:
It replaces the old cable T, made with a Gore cable (for the old scheme see version cable_schemes_v3)
The new one is standard solid wire, with Pyre enamel, double (heavy) insulation.
The bundle is xx cm long, and then is branched till the lemo connectors

MIL-32 contacts	conductors	LEMO contacts	contact description
A	1.A	T1.1	Ls
B	1.B	T1.2	Ls
C	n.c.	n.c.	
D	2.A	T2.1	Ls
E	2.B	T2.2	Ls
F	n.c.	n.c.	
G	3.A	T3.1	Ls
H	3.B	T3.2	Ls
J	n.c.	n.c.	
K	4.A	T4.1	Ls
L	4.B	T4.2	Ls
M	n.c.	n.c.	
N	5.A	T5.1	Ls
P	5.B	T5.2	Ls
R	n.c.	n.c.	
S	6.A	T6.1	Ls
T	6.B	T6.2	Ls
U	n.c.	n.c.	
V			
W			
X			
Y			
Z			
a			
b			
c			
d			

**cable U** (vacuum side)

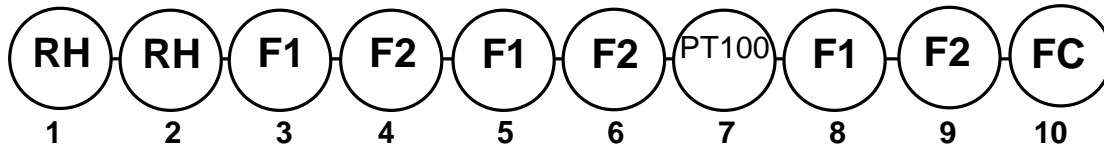
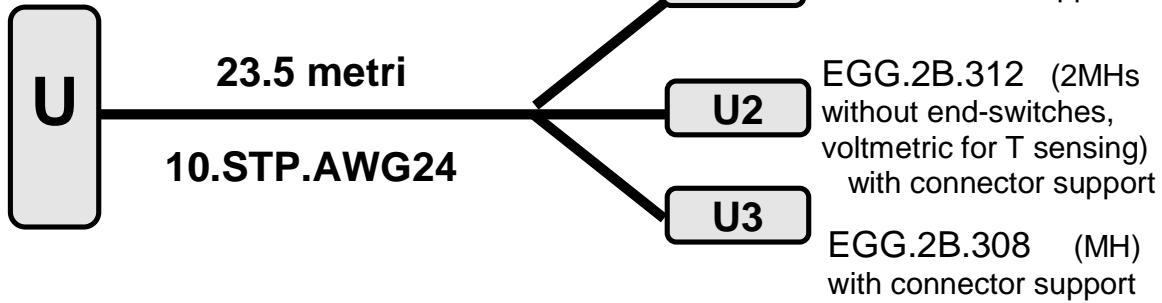

Cutting and Stripping phase
Date:
Operator:
Reel: (primo lotto dei cavi di AdV)

Crimping and Labeling phase
Date:
Operator:
Duration (hours):

Quality Control phase
Date:
Operator:

Cleaning and Storage phase
Date:
Operator:

**Notes:**  
 Rifatto ex-novo a Dicembre 2014 (v4r0). Per lo schema del vecchio cavo U vedere la versione v3. Modificato il 7apr15 (v4r1), dopo nuove esigenze di PAY sorte a WI.  
**NB:** inserire il lemo da pannello nell'apposito clamp a C.  
 Diramare a 20 cm

MIL-32 contacts	conductors	LEMO contacts	contact description
A	1.A	U1.1	RH +
B	1.B	U1.2	RH -
C	1.S	n.c.	
D	2.A	U1.3	RH +
E	2.B	U1.4	RH -
F	2.S	n.c.	
G	3.A	U2.1	F1 +
H	3.B	U2.2	F1 -
J	3.S	n.c.	
K	4.A	U2.3	F2 +
L	4.B	U2.4	F2 -
M	4.S	n.c.	
N	5.A	U2.5	F1 +
P	5.B	U2.6	F1 -
R	5.S	n.c.	
S	6.A	U2.7	F2 +
T	6.B	U2.8	F2 -
U	6.S	n.c.	
V	7.A	U2.9	V+ sense
W	7.B	U2.10	V- sense
X	7.S	n.c.	
Y	8.A	U3.1	F1 +
Z	8.B	U3.2	F1 -
a	8.S	n.c.	
b	9.A	U3.3	F2 +
c	9.B	U3.4	F2 -
d	9.S	n.c.	
e	10.A	U3.5	FC cw
f	10.B	U3.6	FC ccw
g	10.S	U3.7	FC com



**cable V** (Vacuum side)

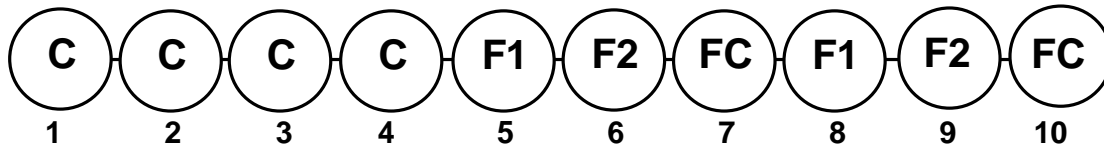
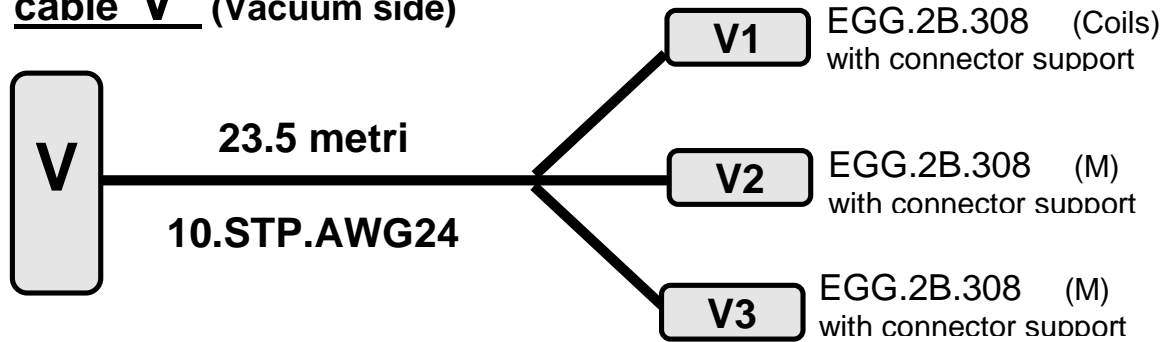

Cutting and Stripping phase
Date:
Operator:
Reel: (primo lotto dei caUi di AdU)

Crimping and Labeling phase
Date:
Operator:
Duration (hours):

Quality Control phase
Date:
Operator:

Cleaning and Storage phase
Date:
Operator:

Notes:
Rifatto ex-novo a Dicembre 2014. Per lo schema del vecchio cavo V vedere la versione v3.
<b>NB:</b> inserire il lemo da pannello nell'apposito clamp a C.
Diramare a 20 cm

MIL-32 contacts	conductors	LEMO contacts	contact description
A	1.A	V1.1	C +
B	1.B	V1.2	C -
C	1.S	n.c.	
D	2.A	V1.3	C +
E	2.B	V1.4	C -
F	2.S	n.c.	
G	3.A	V1.5	C +
H	3.B	V1.6	C -
J	3.S	n.c.	
K	4.A	V1.7	C +
L	4.B	V1.8	C -
M	4.S	n.c.	
N	5.A	V2.1	F1 +
P	5.B	V2.2	F1 -
R	5.S	n.c.	
S	6.A	V2.3	F2 +
T	6.B	V2.4	F2 -
U	6.S	n.c.	
V	7.A	V2.5	FC cw
W	7.B	V2.6	FC ccw
X	7.S	V2.7	FC com
Y	8.A	V3.1	F1 +
Z	8.B	V3.2	F1 -
a	8.S	n.c.	
b	9.A	V3.3	F2 +
c	9.B	V3.4	F2 -
d	9.S	n.c.	
e	10.A	V3.5	FC cw
f	10.B	V3.6	FC ccw
g	10.S	V3.7	FC com

**cable X (vacuum side)**

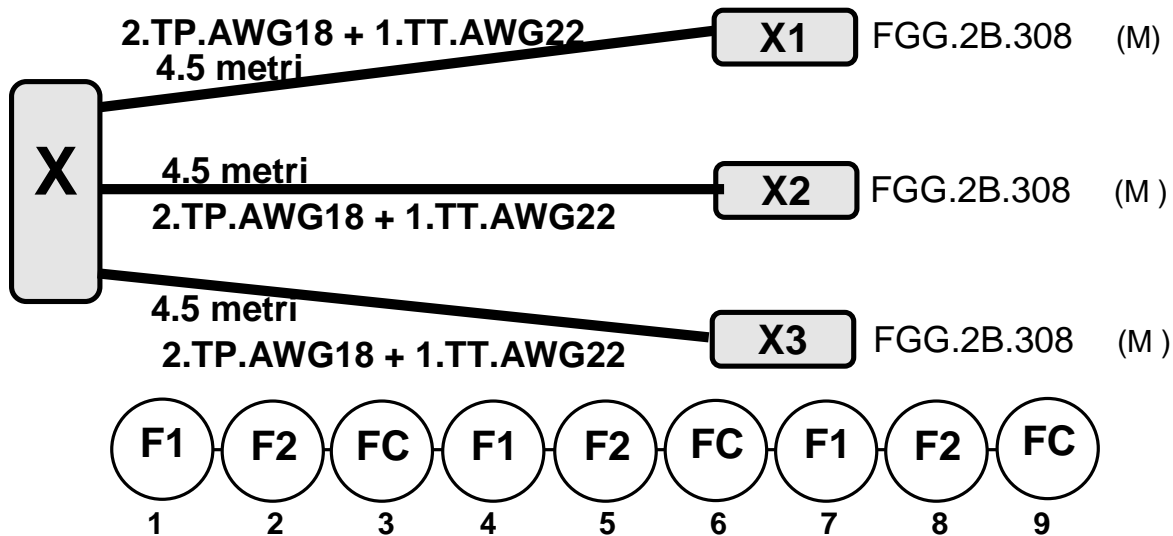

7Cutting and Stripping phase
Date:
Operator: <i>Dattilo, Gherardini</i>
Reel:

Crimping and Labeling phase
Date:
Operator: <i>Dattilo, Gherardini</i>
Duration (hours):

Quality Control phase
Date:
Operator: <i>Dattilo, Gherardini</i>

Cleaning and Storage phase
Date:
Operator: <i>Dattilo, Gherardini</i>

Notes:
I conduttori dei cavi TP e TT vanno identificati utilizzando il tester

MIL-32 contacts	conductors	LEMO contacts	contact description
A	1.A	X1.1	F1 +
B	1.B	X1.2	F1 -
C	2.A	X1.3	F2 +
D	2.B	X1.4	F2 -
E	3.A	X1.5	FC cw
F	3.B	X1.6	FC ccw
G	3.C	X1.7	FC com
H	4.A	X2.1	F1 +
J	4.B	X2.2	F1 -
K	5.A	X2.3	F2 +
L	5.B	X2.4	F2 -
M	6.A	X2.5	FC cw
N	6.B	X2.6	FC ccw
P	6.C	X2.7	FC com
R	7.A	X3.1	F1 +
S	7.B	X3.2	F1 -
T	8.A	X3.3	F2 +
U	8.B	X3.4	F2 -
V	9.A	X3.5	FC cw
W	9.B	X3.6	FC ccw
X	9.C	X3.7	FC com
Y			
Z			
a			
b			
c			
d			

**cable W (vacuum side)**

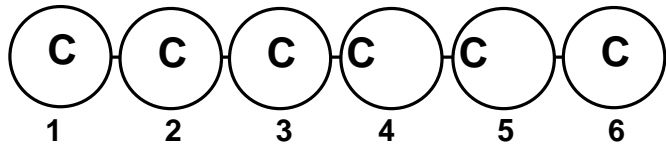
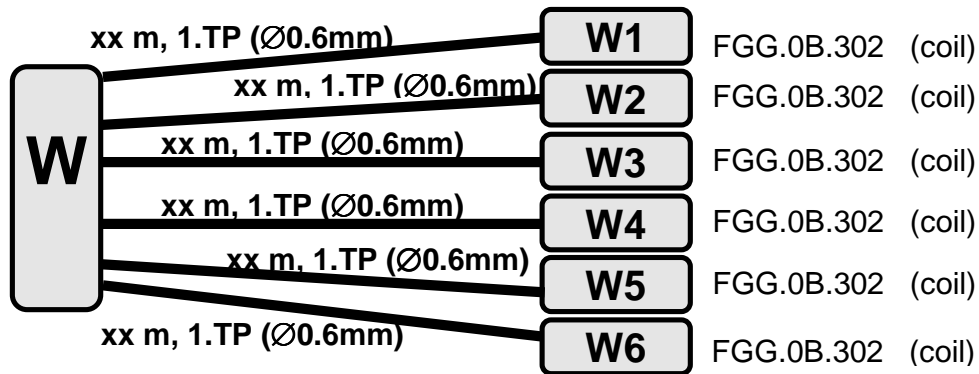

Cutting and Stripping phase		Crimping and Labeling phase	
Date:		Date:	
Operator:		Operator:	
Reel: #xx by MWS, AWG 24 HML		Duration (hours):	
Quality Control phase		Cleaning and Storage phase	
Date:		Date:	
Operator:		Operator:	
Notes:			
It replaces the old cable W, that was made with a Gore cable (for the old scheme see version cable_schemes_v3).			
The new one is standard solid wire, with Pyre enamel, double (heavy) insulation.			
The bundle is xx cm long, and then is branched till the lemo connectors			

MIL-32 contacts	conductors	LEMO contacts	contact description
A	1.A	W1.1	C +
B	1.B	W1.2	C -
C	n.c.	n.c.	
D	2.A	W2.1	C +
E	2.B	W2.2	C -
F	n.c.	n.c.	
G	3.A	W3.1	C +
H	3.B	W3.2	C -
J	n.c.	n.c.	
K	4.A	W4.1	C +
L	4.B	W4.2	C -
M	n.c.	n.c.	
N	5.A	W5.1	C +
P	5.B	W5.2	C -
R	n.c.	n.c.	
S	6.A	W6.1	C +
T	6.B	W6.2	C -
U	n.c.	n.c.	
V			
W			
X			
Y			
Z			
a			
b			
c			
d			

**cable Z (Vacuum side)**

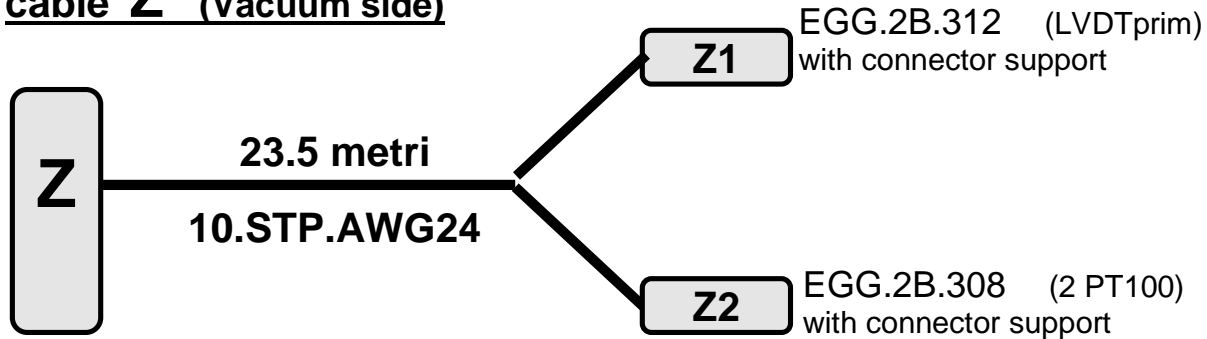

Cutting and Stripping phase
Date:
Operator: <i>Berni</i>
Reel: <i>nuovo</i>

Crimping and Labeling phase
Date: <i>14 – 15 apr 2015</i>
Operator: <i>Berni / Gherardini</i>
Duration (hours):

Quality Control phase
Date:
Operator:

Cleaning and Storage phase
Date:
Operator:

Notes:
Nuovo, creato per AdV. Per collegare i primari degli attuatori/LVDT del F#. Usato anche per i sensori di temperatura del RH e del payload. <b>NB:</b> inserire il lemo da pannello nell'apposito clamp a C. Diramare a 20 cm

MIL-32 contacts	conductors	ODU / LEMO contacts	contact description
A	1.A	Z1.1	Lp
B	1.B	Z1.2	Lp
C	1.S	n.c.	
D	2.A	Z1.3	Lp
E	2.B	Z1.4	Lp
F	2.S	n.c.	
G	3.A	Z1.5	Lp
H	3.B	Z1.6	Lp
J	3.S	n.c.	
K	4.A	Z1.7	Lp
L	4.B	Z1.8	Lp
M	4.S	n.c.	
N	5.A	Z1.9	Lp
P	5.B	Z1.10	Lp
R	5.S	n.c.	
S	6.A	Z1.11	Lp
T	6.B	Z1.12	Lp
U	6.S	n.c.	
V	7.A	Z2.1	PT100 V+
W	7.B	Z2.2	PT100 V-
X	7.S	n.c.	
Y	8.A	Z2.3	PT100 A+
Z	8.B	Z2.4	PT100 A-
a	8.S	n.c.	
b	9.A	Z2.5	PT100 V+
c	9.B	Z2.6	PT100 V-
d	9.S	n.c.	
e	10.A	Z2.7	PT100 A+
f	10.B	Z2.8	PT100 A-
	10.S	n.c.	

