

CABLE ASSEMBLY SCHEMES
for **North End** cabling

Change History

Version	Date	Changes/Reasons	Authors
v0		initial suspension cabling	Ceccanti, Dattilo, Nenci
v1	2003	added cabling of sensors and actuators on Filter #7	Dattilo, Nenci
v2	Dec 2010	Added cabling for internal CHRoCC (cables U and X) Added 2 temperature sensors close to the RefMass (cable U)	Dattilo, Gherardini
v3	May 2013	Modified cabling for allow new separating roof and new payload (cables F,R,S,T,V). Cables U and X suppressed. No more tiltmeters on F#7, more devices on payload.	Berni, Dattilo, Gherardini
v3r1	Oct 2013	Replaced cables T and W for the new F#7 actuation/sensing system	Berni, Dattilo, Gherardini
v3r2	Nov 2015	Added cables U (for RH), Z (for F#7 LVDT primary coils), P and Q (for LVDTs and Piezos of IP feet) and Replaced cables T and W with one made of UHV wire	Berni, Dattilo, Gherardini

Contents

Informazioni generali.....	3
Identificazione componenti.....	3
Legenda	4
LEMO pinout of the main devices	4
CABLE A (VACUUM SIDE)	5
CABLE B (VACUUM SIDE)	6
CABLE C (VACUUM SIDE)	7
CABLE D (VACUUM SIDE)	8
CABLE E (VACUUM SIDE).....	9
CABLE F (VACUUM SIDE).....	10
CABLE G (VACUUM SIDE)	11
CABLE H (VACUUM SIDE)	12
CABLE J (VACUUM SIDE).....	13
CABLE K (VACUUM SIDE)	14
CABLE L (VACUUM SIDE).....	15
CABLE M (VACUUM SIDE)	16
CABLE N (VACUUM SIDE)	17
CABLE O (VACUUM SIDE)	18
CABLE P (VACUUM SIDE).....	19
CABLE Q (VACUUM SIDE)	20
CABLE R (VACUUM SIDE)	21
CABLE S (VACUUM SIDE).....	22
CABLE T (VACUUM SIDE).....	23
CABLE U (VACUUM SIDE)	24
CABLE V (VACUUM SIDE).....	25
CABLE W (VACUUM SIDE).....	26
CABLE Z (VACUUM SIDE).....	27

Informazioni generali

Ciascun spezzone di cavo va terminato ad una estremità da un connettore circolare 32 poli (tipo presa, con sockets), all'altra estremità con uno o più connettori Lemo multipolari (generalmente tipo spina, con pins). I cavi sono del tipo:

- cavo piatto a 18 o 20 conduttori AWG 24 a coppie intrecciate e schermate singolarmente (cavo STP).
- cavo assemblato in lab a conduttori solidi AWG 18 o AWG 24, isolati in polimide, a coppie ritorte (cavo TP).
-

Identificazione componenti

- Ciascun cavo è identificato da una lettera dell'alfabeto.
- Il tipo di cavo utilizzato e' indicato in prossimità del disegno: la sigla comprende il numero di coppie di conduttori, il tipo di schermatura (STP), la sezione (AWG24). Es.: la sigla **9.STP.AWG24** specifica un tipo di cavo avente 18 conduttori intrecciati e schermati a coppie, di sezione AWG24
- Ciascun conduttore di un cavo STP è identificato da un numero cardinale relativo alla coppia (**1** per la coppia bianco/rossa a seguire fino ad **9** per le altre coppie bianco/gialle), da una lettera (**A** per il conduttore con isolante a strisce rosse, **B** per l'altro conduttore della coppia, **S** per la calza) (es. la calza nella terza coppia, è identificata da **3.S**).
- Ciascun connettore Lemo è identificato da due caratteri: il primo è la lettera del cavo sul quale è saldato il connettore, il secondo è un numero cardinale, che va da 1 al n. max di connettori Lemo sullo stesso cavo (es. per il cavo **B** terminato da due Lemo, essi sono identificati da **B1** e **B2**)
- I contatti di ciascun connettore Lemo sono identificati dal nome del connettore, seguito dal numero del contatto indicato sull'isolante del connettore (es. il contatto¹ n. 4 che si trova sul connettore Lemo **B3** e' identificato da **B3.4**)
- I contatti di ciascun connettore circolare a 32 poli sono identificati da lettere (A÷Z, a÷j). Per quelli interni vale il pinout serigrafato sul retro dell'isolante, per quelli esterni vale il pinout standard

¹ Nel caso di conduttori Lemo, il contatto n. 1 e' quello col semicerchio bianco, i successivi sono quelli lungo la linea bianca che parte dal contatto n. 1.

Legenda

F1 +	motore, fase 1, positivo
F1 -	motore, fase 1, negativo
F2 +	motore, fase 2, positivo
F2 -	motore, fase 2, negativo
FC fw	motore, fine corsa, forward
FC bw	motore, fine corsa, backard
FC com	motore, fine corsa, comune
RST up	motore, reostato, terminale superiore
RST down	motore, reostato, terminale inferiore
RST com	motore, reostato, comune o cursore
TP sx +	thermal probe, sinistro, positivo
TP sx -	thermal probe, sinistro, negativo
TP dx +	thermal probe, destro, positivo
TP dx -	thermal probe, destro, negativo
Ls	LVDT, secondario
Lp	LVDT, primario
C +	coil attuatore, positivo
C -	coil attuatore, negativo
fbk	accelerometro, feedback
V _H	Voltmetrico alto
V _L	Voltmetrico basso
A _H	Amperometrico alto
A _L	Amperometrico basso
He	Heater

LEMO pinout of the main devices

ACCELEROMETER	
LEMO contacts	Contact descript.
1	Lp
2	Lp
3	
4	F1 +
5	F1 -
6	F2 +
7	F2 -
8	
9	FC sx
11	FC dx
10	FC com
12	fbk
13	fbk
14	
15	Ls
16	Ls
17	
18	

LVDT	
LEMO contacts	Contact descript.
1	Lp +
2	Lp -
3	Ls +
4	Ls -

COIL	
LEMO contacts	Contact descript.
1	C +
2	C -

MOTOR		
LEMO contacts	Contact descript.	UTG 12p contacts
1	F1 +	A
2	F1 -	B
	F1 shield	C
3	F2 +	D
4	F2 -	E
	F2 shield	F
5	FC fw	G
6	FC bw	H
7	FC com	J
8	n.c.	

cable A (vacuum side)

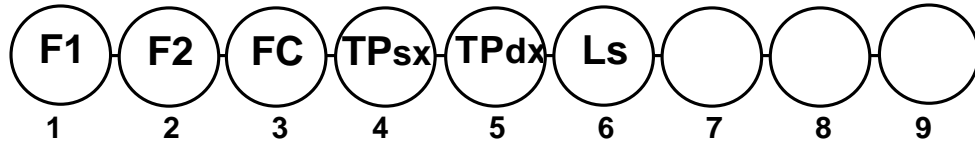
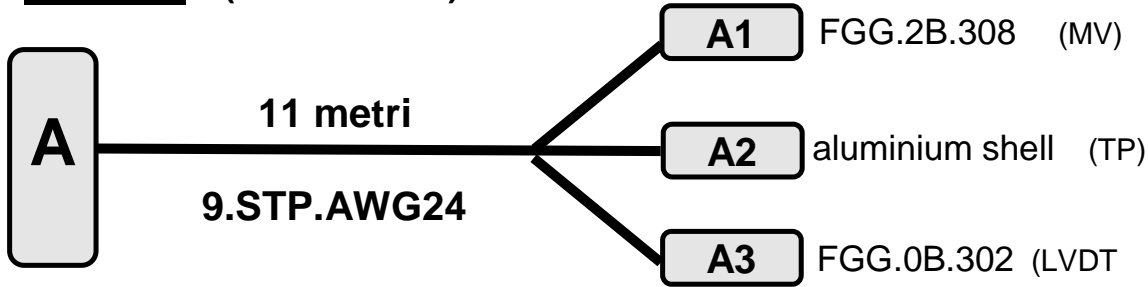

Cutting and Stripping phase
Date:
Operator:
Reel:

Crimping and Labeling phase
Date:
Operator:
Duration (hours):

Quality Control phase
Date:
Operator:

Cleaning and Storage phase
Date:
Operator:

Notes:
Diramare a 60 cm

MIL-32 contacts	conductors	LEMO contacts	contact description
A	1.A	A1.1	F1 +
B	1.B	A1.2	F1 -
C	1.S	n.c.	
D	2.A	A1.3	F2 +
E	2.B	A1.4	F2 -
F	2.S	n.c.	
G	3.A	A1.5	FC sx
H	3.B	A1.6	FC dx
J	3.S	A1.7	FC com
K	4.A	A2	TP sx +
L	4.B	A2	TP sx -
M	4.S	n.c.	
N	5.A	A2	TP dx +
P	5.B	A2	TP dx -
R	5.S	n.c.	
S	6.A	A3.1	Ls
T	6.B	A3.2	Ls
U	6.S	n.c.	
V	7.A		
W	7.B		
X	7.S		
Y	8.A		
Z	8.B		
a	8.S		
b	9.A		
c	9.B		
d	9.S		

cable B (vacuum side)

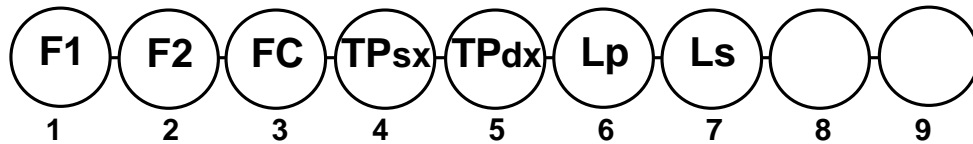
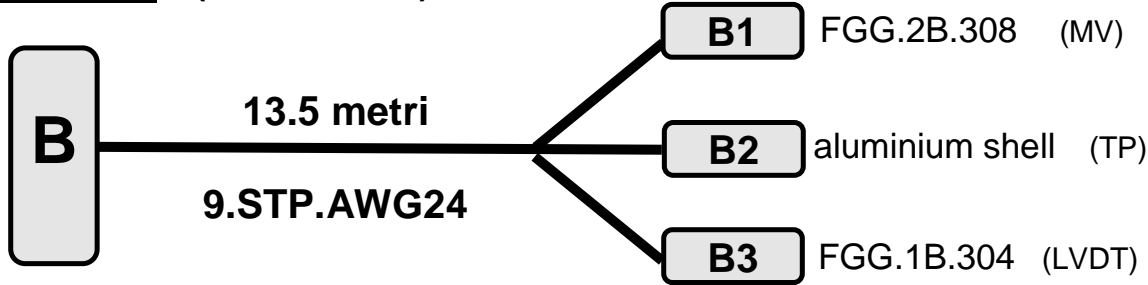

Cutting and Stripping phase
Date:
Operator:
Reel:

Crimping and Labeling phase
Date:
Operator:
Duration (hours):

Quality Control phase
Date:
Operator:

Cleaning and Storage phase
Date:
Operator:

Notes:
Diramare a 60 cm

MIL-32 contacts	conductors	LEMO contacts	contact description
A	1.A	B1.1	F1 +
B	1.B	B1.2	F1 -
C	1.S	n.c.	
D	2.A	B1.3	F2 +
E	2.B	B1.4	F2 -
F	2.S	n.c.	
G	3.A	B1.5	FC sx
H	3.B	B1.6	FC dx
J	3.S	B1.7	FC com
K	4.A	B2	TP sx +
L	4.B	B2	TP sx -
M	4.S	n.c.	
N	5.A	B2	TP dx +
P	5.B	B2	TP dx -
R	5.S	n.c.	
S	6.A	B3.1	Lp
T	6.B	B3.2	Lp
U	6.S	n.c.	
V	7.A	B3.3	Ls
W	7.B	B3.4	Ls
X	7.S	n.c.	
Y	8.A		
Z	8.B		
a	8.S		
b	9.A		
c	9.B		
d	9.S		

cable C (vacuum side)

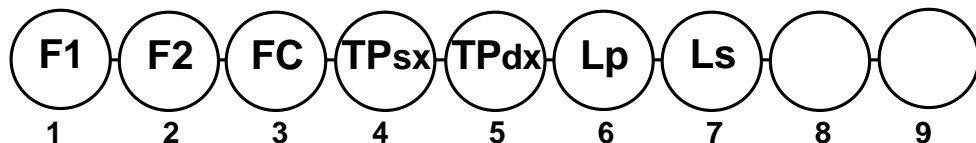
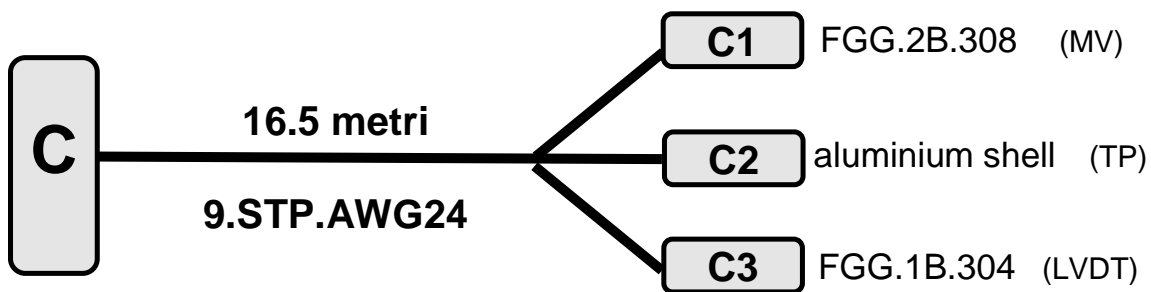

Cutting and Stripping phase
Date:
Operator:
Reel:

Crimping and Labeling phase
Date:
Operator:
Duration (hours):

Quality Control phase
Date:
Operator:

Cleaning and Storage phase
Date:
Operator:

Notes:
Diramare a 60 cm

MIL-32 contacts	conductors	LEMO contacts	contact description
A	1.A	C1.1	F1 +
B	1.B	C1.2	F1 -
C	1.S	n.c.	
D	2.A	C1.3	F2 +
E	2.B	C1.4	F2 -
F	2.S	n.c.	
G	3.A	C1.5	FC sx
H	3.B	C1.6	FC dx
J	3.S	C1.7	FC com
K	4.A	C2	TP sx +
L	4.B	C2	TP sx -
M	4.S	n.c.	
N	5.A	C2	TP dx +
P	5.B	C2	TP dx -
R	5.S	n.c.	
S	6.A	C3.1	Lp
T	6.B	C3.2	Lp
U	6.S	n.c.	
V	7.A	C3.3	Ls
W	7.B	C3.4	Ls
X	7.S	n.c.	
Y	8.A		
Z	8.B		
a	8.S		
b	9.A		
c	9.B		
d	9.S		

cable D (vacuum side)

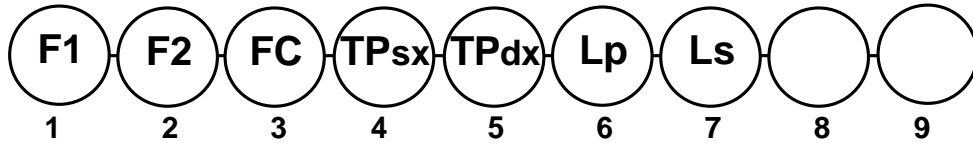
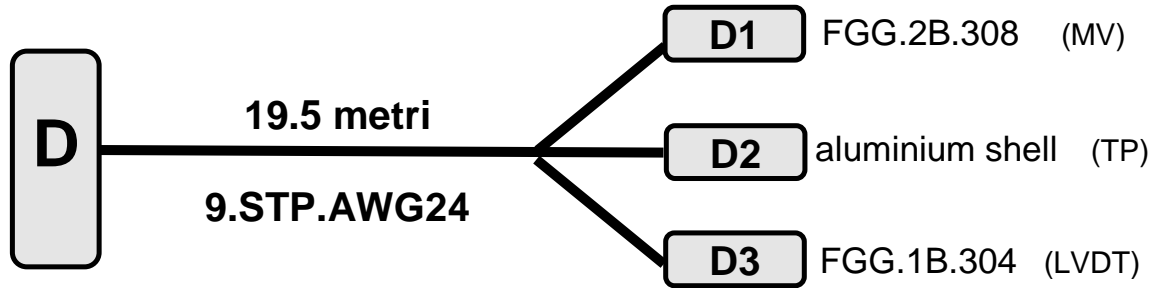

Cutting and Stripping phase
Date:
Operator:
Reel:

Crimping and Labeling phase
Date:
Operator:
Duration (hours):

Quality Control phase
Date:
Operator:

Cleaning and Storage phase
Date:
Operator:

Notes:
Diramare a 60 cm

MIL-32 contacts	conductors	LEMO contacts	contact description
A	1.A	D1.1	F1 +
B	1.B	D1.2	F1 -
C	1.S	n.c.	
D	2.A	D1.3	F2 +
E	2.B	D1.4	F2 -
F	2.S	n.c.	
G	3.A	D1.5	FC sx
H	3.B	D1.6	FC dx
J	3.S	D1.7	FC com
K	4.A	D2	TP sx +
L	4.B	D2	TP sx -
M	4.S	n.c.	
N	5.A	D2	TP dx +
P	5.B	D2	TP dx -
R	5.S	n.c.	
S	6.A	D3.1	Lp
T	6.B	D3.2	Lp
U	6.S	n.c.	
V	7.A	D3.3	Ls
W	7.B	D3.4	Ls
X	7.S	n.c.	
Y	8.A		
Z	8.B		
a	8.S		
b	9.A		
c	9.B		
d	9.S		

cable E (vacuum side)

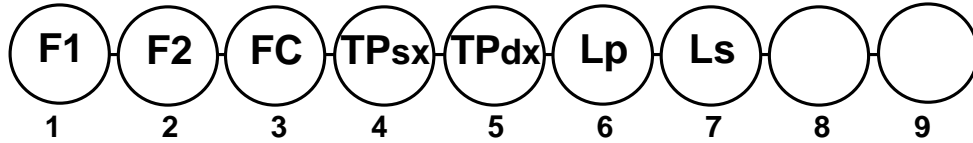
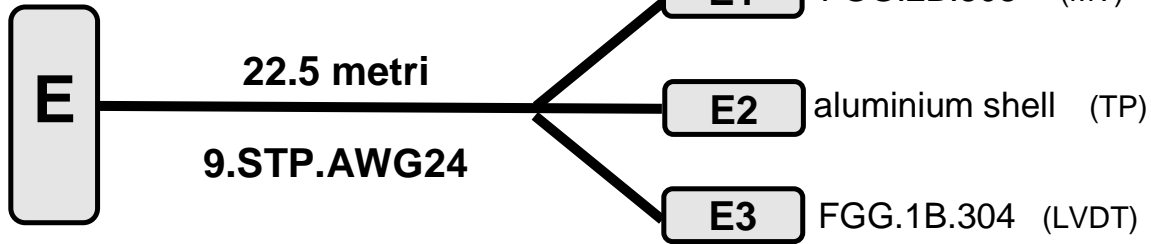

Cutting and Stripping phase
Date:
Operator:
Reel:

Crimping and Labeling phase
Date:
Operator:
Duration (hours):

Quality Control phase
Date:
Operator:

Cleaning and Storage phase
Date:
Operator:

Notes:
Diramare a 60 cm

MIL-32 contacts	conductors	LEMO contacts	contact description
A	1.A	E1.1	F1 +
B	1.B	E1.2	F1 -
C	1.S	n.c.	
D	2.A	E1.3	F2 +
E	2.B	E1.4	F2 -
F	2.S	n.c.	
G	3.A	E1.5	FC sx
H	3.B	E1.6	FC dx
J	3.S	E1.7	FC com
K	4.A	E2	TP sx +
L	4.B	E2	TP sx -
M	4.S	n.c.	
N	5.A	E2	TP dx +
P	5.B	E2	TP dx -
R	5.S	n.c.	
S	6.A	E3.1	Lp
T	6.B	E3.2	Lp
U	6.S	n.c.	
V	7.A	E3.3	Ls
W	7.B	E3.4	Ls
X	7.S	n.c.	
Y	8.A		
Z	8.B		
a	8.S		
b	9.A		
c	9.B		
d	9.S		

cable F (vacuum side)

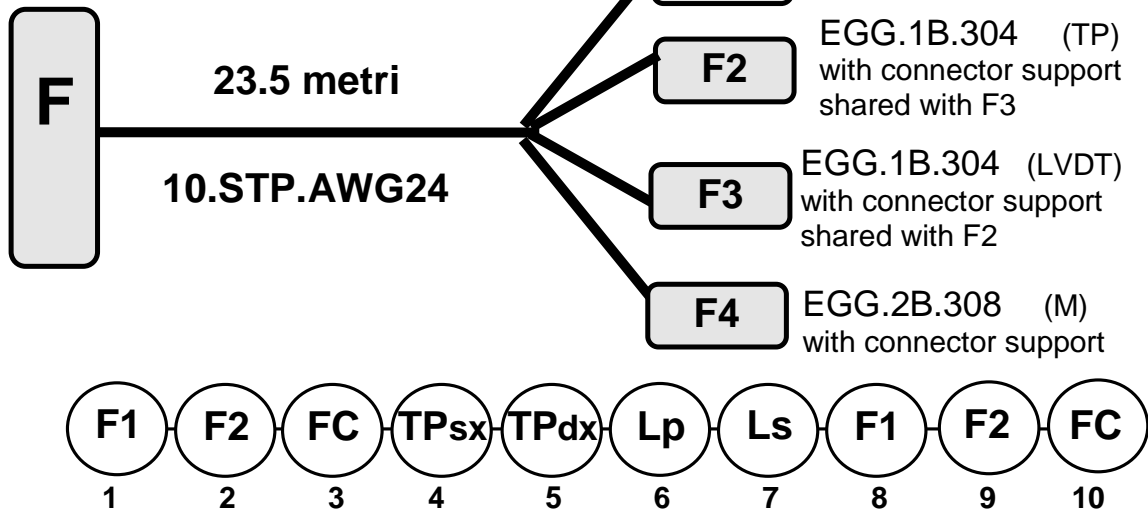

Cutting and Stripping phase
Date:
Operator: <i>F.Berni</i>
Reel: (primo lotto dei cavi di AdV)

Crimping and Labeling phase
Date:
Operator: <i>F.Berni</i>
Duration (hours):

Quality Control phase
Date:
Operator:

Cleaning and Storage phase
Date:
Operator:

Notes:
Rifatto ex-novo a maggio 2013. Per lo schema del vecchio cavo F vedere la versione v2.
NB: inserire il lemo da pannello nell'apposito clamp a C.
Diramare a 20 cm
Il 10nov2015 messi Lemo F2 ad F3 sullo stesso clamp a C

MIL-32 contacts	conductors	LEMO contacts	contact description
A	1.A	F1.1	F1 +
B	1.B	F1.2	F1 -
C	1.S	n.c.	
D	2.A	F1.3	F2 +
E	2.B	F1.4	F2 -
F	2.S	n.c.	
G	3.A	F1.5	FC sx
H	3.B	F1.6	FC dx
J	3.S	F1.7	FC com
K	4.A	F2.1	TP sx +
L	4.B	F2.2	TP sx -
M	4.S	n.c.	
N	5.A	F2.3	TP dx +
P	5.B	F2.4	TP dx -
R	5.S	n.c.	
S	6.A	F3.1	Lp
T	6.B	F3.2	Lp
U	6.S	n.c.	
V	7.A	F3.3	Ls
W	7.B	F3.4	Ls
X	7.S	n.c.	
Y	8.A	F4.1	F1 +
Z	8.B	F4.2	F1 -
a	8.S	n.c.	
b	9.A	F4.3	F2 +
c	9.B	F4.4	F2 -
d	9.S	n.c.	
e	10.A	F4.5	FC sx
f	10.B	F4.6	FC dx
g	10.S	F4.7	FC com

cable G (vacuum side)

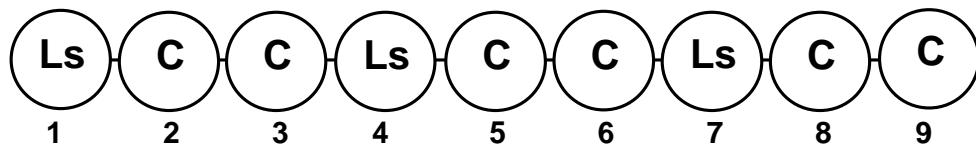
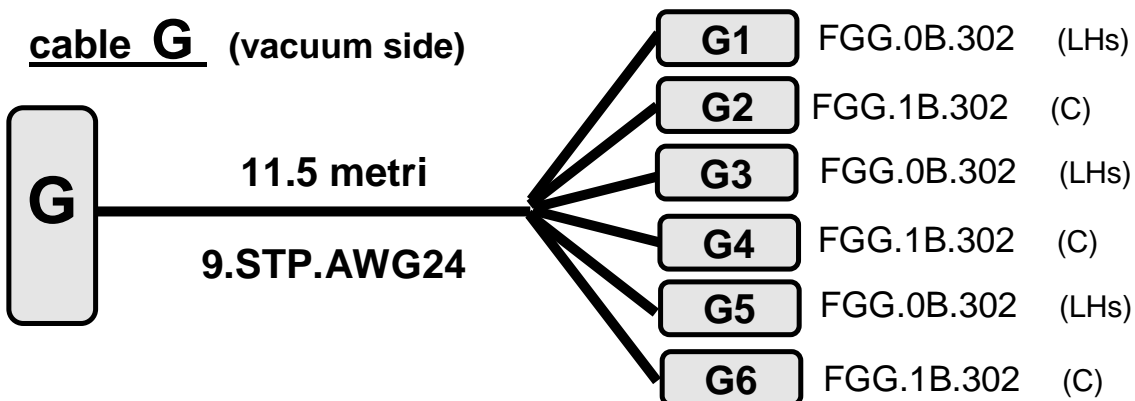

Cutting and Stripping phase
Date:
Operator:
Reel:

Crimping and Labeling phase
Date:
Operator:
Duration (hours):

Quality Control phase
Date:
Operator:

Cleaning and Storage phase
Date:
Operator:

Notes:
Diramare a gruppi (G1+G2, G3+G4, G5+G6) di <u>2.5 metri</u> ;
Diramare G1, G2, G3, G4, G5, G6 di <u>1.0 metro</u> ;
Scorciare G1+G2 di <u>0.5 metri</u> rispetto ai 11.5 metri totali;
Scorciare G3+G4 di <u>1.5 metri</u> rispetto ai 11.5 metri totali;
Ponticelli su MIL-32.

MIL-32 contacts	conductors	LEMO contacts	contact description
A	1.A	G1.1	Ls
B	1.B	G1.2	Ls
C	1.S	n.c.	
D	2.A	G2.1	C +
E	2.B	G2.2	C -
F	2.S	n.c.	
G	3.A	G2.1	C +
H	3.B	G2.2	C -
J	3.S	n.c.	
K	4.A	G3.1	Ls
L	4.B	G3.2	Ls
M	4.S	n.c.	
N	5.A	G4.1	C +
P	5.B	G4.2	C -
R	5.S	n.c.	
S	6.A	G4.1	C +
T	6.B	G4.2	C -
U	6.S	n.c.	
V	7.A	G5.1	Ls
W	7.B	G5.2	Ls
X	7.S	n.c.	
Y	8.A	G6.1	C +
Z	8.B	G6.2	C -
a	8.S	n.c.	
b	9.A	G6.1	C +
c	9.B	G6.2	C -
d	9.S	n.c.	

cable H (vacuum side)

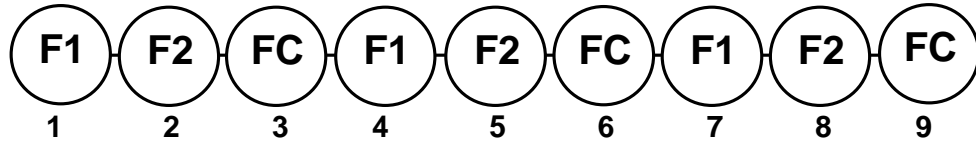
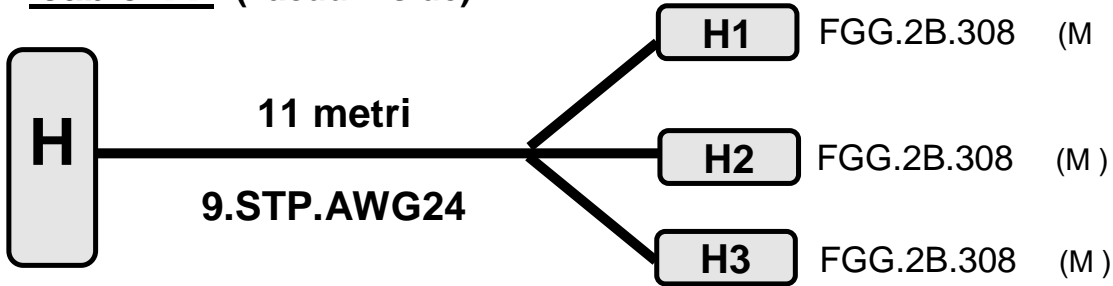

Cutting and Stripping phase
Date:
Operator:
Reel:

Crimping and Labeling phase
Date:
Operator:
Duration (hours):

Quality Control phase
Date:
Operator:

Cleaning and Storage phase
Date:
Operator:

Notes:
Diramare di <u>2,5 metri</u> ; Scorciare H2 di <u>1.5 metri</u> .

MIL-32 contacts	conductors	LEMO contacts	contact description
A	1.A	H1.1	F1 +
B	1.B	H1.2	F1 -
C	1.S	n.c.	
D	2.A	H1.3	F2 +
E	2.B	H1.4	F2 -
F	2.S	n.c.	
G	3.A	H1.5	FC sx
H	3.B	H1.6	FC dx
J	3.S	H1.7	FC com
K	4.A	H2.1	F1 +
L	4.B	H2.2	F1 -
M	4.S	n.c.	
N	5.A	H2.3	F2 +
P	5.B	H2.4	F2 -
H	5.S	n.c.	
S	6.A	H2.5	FC sx
T	6.B	H2.6	FC dx
U	6.S	H2.7	FC com
V	7.A	H3.1	F1 +
W	7.B	H3.2	F1 -
X	7.S	n.c.	
Y	8.A	H3.3	F2 +
Z	8.B	H3.4	F2 -
a	8.S	n.c.	
b	9.A	H3.5	FC sx
c	9.B	H3.6	FC dx
d	9.S	H3.7	FC com

cable J (vacuum side)

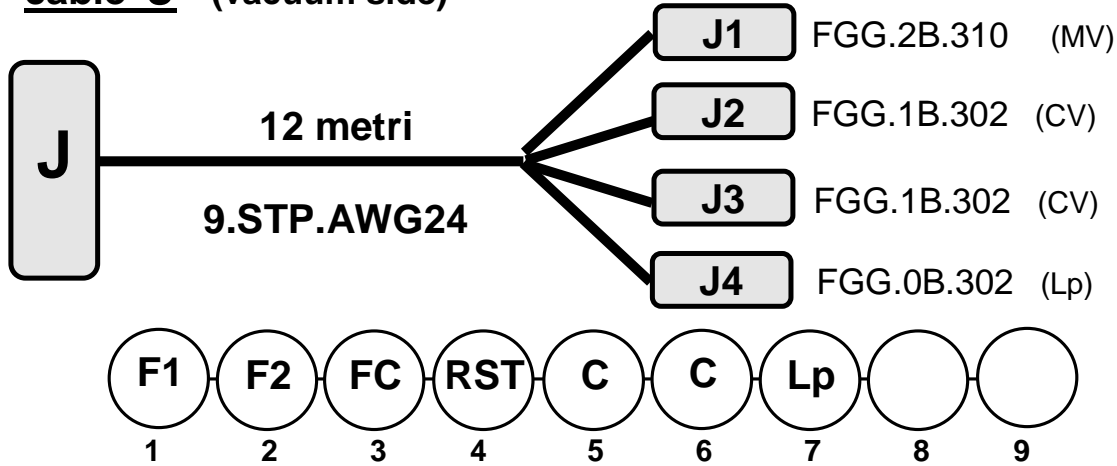

Cutting and Stripping phase
Date:
Operator:
Reel:

Crimping and Labeling phase
Date:
Operator:
Duration (hours):

Quality Control phase
Date:
Operator:

Cleaning and Storage phase
Date:
Operator:

Notes:	
<p>Diramare a 120 cm tra J2 e J3; Diramare J3 e J4 di 25 cm; Scorciare J1 di 120 cm; Scorciare J2 di 20 cm.</p>	<p>RST e' il reostato, usato come sensore di posizione dell'hoist.</p>

MIL-32 contacts	conductors	LEMO contacts	contact description
A	1.A	J1.1	F1 +
B	1.B	J1.2	F1 -
C	1.S	n.c.	
D	2.A	J1.3	F2 +
E	2.B	J1.4	F2 -
F	2.S	n.c.	
G	3.A	J1.5	FC sx
H	3.B	J1.6	FC dx
J	3.S	J1.7	FC com
K	4.A	J1.8	RST
L	4.B	J1.9	RST
M	4.S	J1.10	RST com
N	5.A	J2.1	C+
P	5.B	J2.2	C-
R	5.S	n.c.	
S	6.A	J3.1	C+
T	6.B	J3.2	C-
U	6.S	n.c.	
V	7.A	J4.1	Lp
W	7.B	J4.2	Lp
X	7.S	n.c.	
Y	8.A		
Z	8.B		
a	8.S		
b	9.A		
c	9.B		
d	9.S		

cable K (vacuum side)

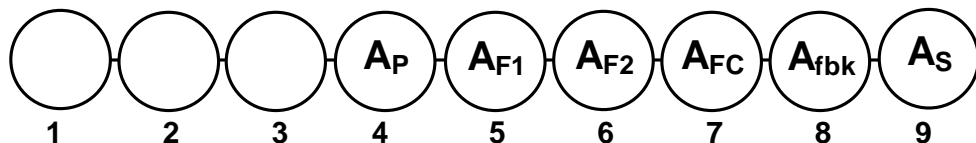
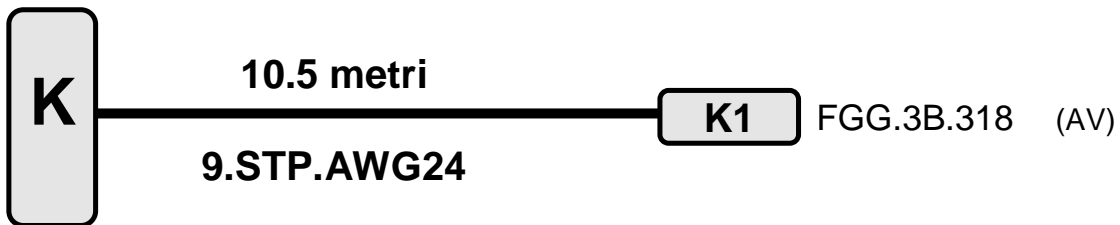

Cutting and Stripping phase
Date:
Operator:
Reel:

Crimping and Labeling phase
Date:
Operator:
Duration (hours):

Quality Control phase
Date:
Operator:

Cleaning and Storage phase
Date:
Operator:

Notes:

MIL-32 contacts	conductors	LEMO contacts	contact description
A	1.A		
B	1.B		
C	1.S		
D	2.A		
E	2.B		
F	2.S		
G	3.A		
H	3.B		
J	3.S		
K	4.A	K1.1	Lp
L	4.B	K1.2	Lp
M	4.S	K1.3	
N	5.A	K1.4	F1 +
P	5.B	K1.5	F1 -
R	5.S	K1.8	
S	6.A	K1.6	F2 +
T	6.B	K1.7	F2 -
U	6.S	K1.18	
V	7.A	K1.9	FC sx
W	7.B	K1.11	FC dx
X	7.S	K1.10	FC com
Y	8.A	K1.12	fbk
Z	8.B	K1.13	fbk
a	8.S	K1.14	
b	9.A	K1.15	Ls
c	9.B	K1.16	Ls
d	9.S	K1.17	

cable L (vacuum side)

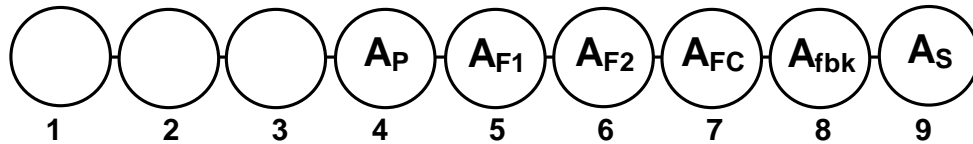
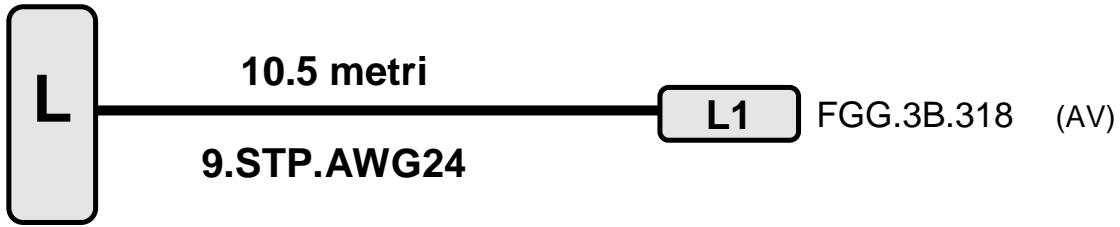

Cutting and Stripping phase
Date:
Operator:
Reel:

Crimping and Labeling phase
Date:
Operator:
Duration (hours):

Quality Control phase
Date:
Operator:

Cleaning and Storage phase
Date:
Operator:

Notes:

MIL-32 contacts	conductors	LEMO contacts	contact description
A	1.A		
B	1.B		
C	1.S		
D	2.A		
E	2.B		
F	2.S		
G	3.A		
H	3.B		
J	3.S		
K	4.A	L1.1	Lp
L	4.B	L1.2	Lp
M	4.S	L1.3	
N	5.A	L1.4	F1 +
P	5.B	L1.5	F1 -
R	5.S	L1.8	
S	6.A	L1.6	F2 +
T	6.B	L1.7	F2 -
U	6.S	L1.18	
V	7.A	L1.9	FC sx
W	7.B	L1.11	FC dx
X	7.S	L1.10	FC com
Y	8.A	L1.12	fbk
Z	8.B	L1.13	fbk
a	8.S	L1.14	
b	9.A	L1.15	Ls
c	9.B	L1.16	Ls
d	9.S	L1.17	

cable M (vacuum side)

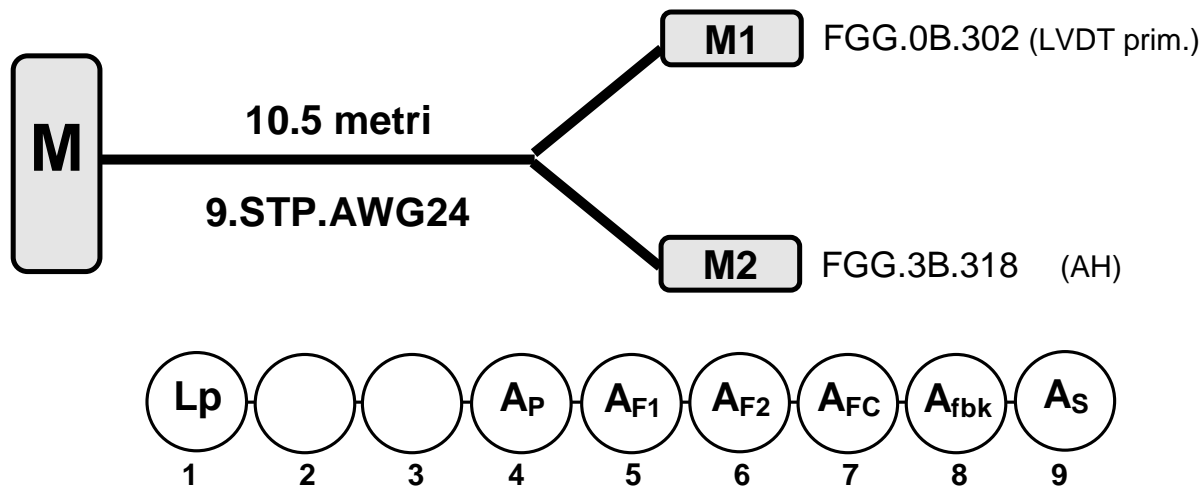

Cutting and Stripping phase
Date:
Operator:
Reel:

Crimping and Labeling phase
Date:
Operator:
Duration (hours):

Quality Control phase
Date:
Operator:

Cleaning and Storage phase
Date:
Operator:

Notes:
Diramare a 60 cm

MIL-32 contacts	conductors	LEMO contacts	contact description
A	1.A	M1.1	Lp
B	1.B	M1.2	Lp
C	1.S	n.c.	
D	2.A		
E	2.B		
F	2.S		
G	3.A		
H	3.B		
J	3.S		
K	4.A	M2.1	Lp
L	4.B	M2.2	Lp
M	4.S	M2.3	
N	5.A	M2.4	F1 +
P	5.B	M2.5	F1 -
R	5.S	M2.8	
S	6.A	M2.6	F2 +
T	6.B	M2.7	F2 -
U	6.S	M2.18	
V	7.A	M2.9	FC sx
W	7.B	M2.11	FC dx
X	7.S	M2.10	FC com
Y	8.A	M2.12	fbk
Z	8.B	M2.13	fbk
a	8.S	M2.14	
b	9.A	M2.15	Ls
c	9.B	M2.16	Ls
d	9.S	M2.17	

cable N (vacuum side)

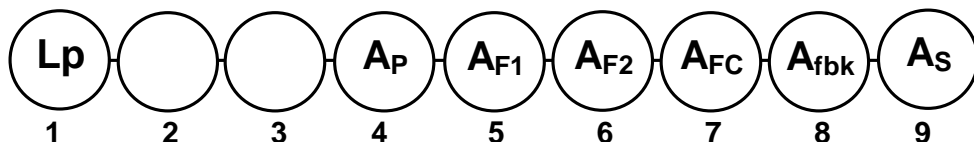
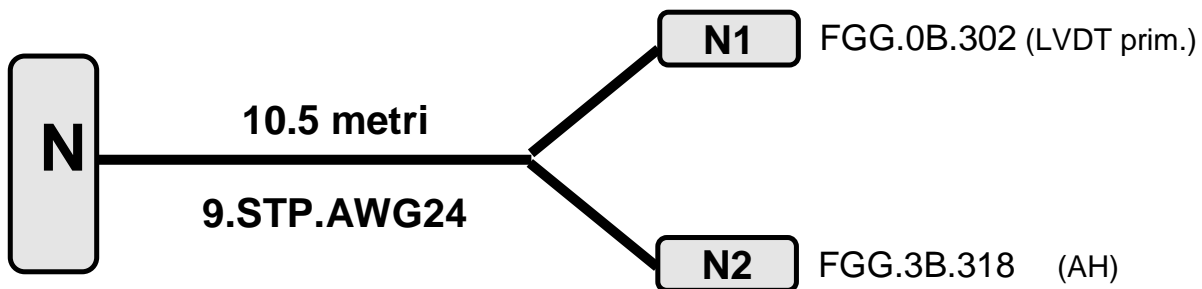

Cutting and Stripping phase
Date:
Operator:
Reel:

Crimping and Labeling phase
Date:
Operator:
Duration (hours):

Quality Control phase
Date:
Operator:

Cleaning and Storage phase
Date:
Operator:

Notes:
Diramare a 60 cm

MIL-32 contacts	conductors	LEMO contacts	contact description
A	1.A	N1.1	Lp
B	1.B	N1.2	Lp
C	1.S	n.c.	
D	2.A		
E	2.B		
F	2.S		
G	3.A		
H	3.B		
J	3.S		
K	4.A	N2.1	Lp
L	4.B	N2.2	Lp
M	4.S	N2.3	
N	5.A	N2.4	F1 +
P	5.B	N2.5	F1 -
R	5.S	N2.8	
S	6.A	N2.6	F2 +
T	6.B	N2.7	F2 -
U	6.S	N2.18	
V	7.A	N2.9	FC sx
W	7.B	N2.11	FC dx
X	7.S	N2.10	FC com
Y	8.A	N2.12	fbk
Z	8.B	N2.13	fbk
a	8.S	N2.14	
b	9.A	N2.15	Ls
c	9.B	N2.16	Ls
d	9.S	N2.17	

cable O (vacuum side)

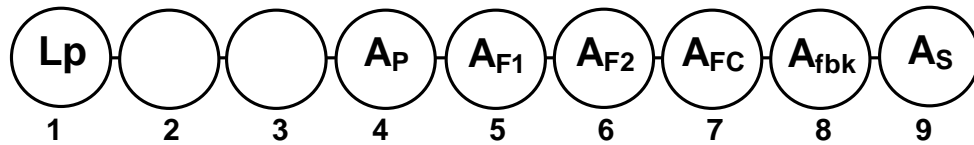
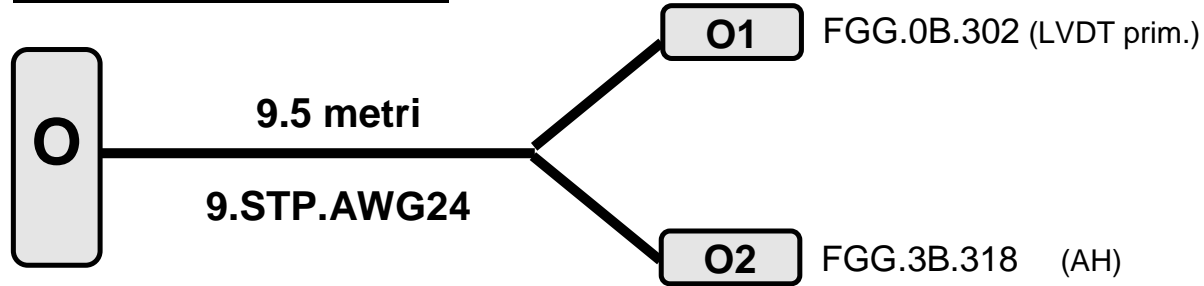

Cutting and Stripping phase
Date:
Operator:
Reel:

Crimping and Labeling phase
Date:
Operator:
Duration (hours):

Quality Control phase
Date:
Operator:

Cleaning and Storage phase
Date:
Operator:

Notes:
Diramare a 60 cm

MIL-32 contacts	conductors	LEMO contacts	contact description
A	1.A	O1.1	Lp
B	1.B	O1.2	Lp
C	1.S	n.c.	
D	2.A		
E	2.B		
F	2.S		
G	3.A		
H	3.B		
J	3.S		
K	4.A	O2.1	Lp
L	4.B	O2.2	Lp
M	4.S	O2.3	
N	5.A	O2.4	F1 +
P	5.B	O2.5	F1 -
R	5.S	O2.8	
S	6.A	O2.6	F2 +
T	6.B	O2.7	F2 -
U	6.S	O2.18	
V	7.A	O2.9	FC sx
W	7.B	O2.11	FC dx
X	7.S	O2.10	FC com
Y	8.A	O2.12	fbk
Z	8.B	O2.13	fbk
a	8.S	O2.14	
b	9.A	O2.15	Ls
c	9.B	O2.16	Ls
d	9.S	O2.17	

Cable P (vacuum side)

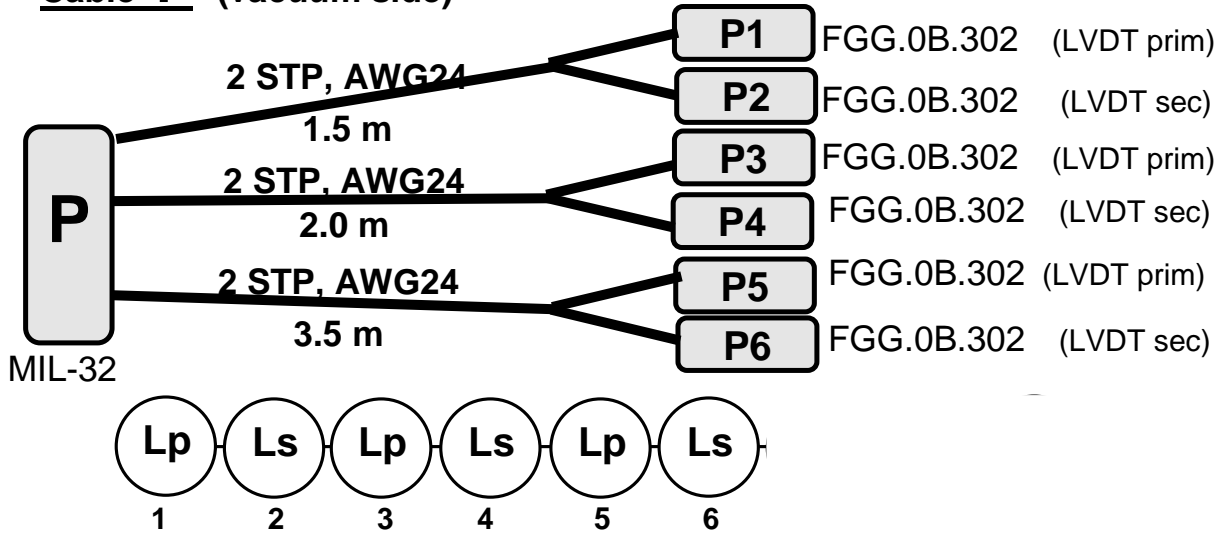

MIL-32 contacts	conductors	LEMO contacts	contact description
A	1.A	P1.1	Lp
B	1.B	P1.2	Lp
C	1.S	n.c.	
D	2.A	P2.3	Ls
E	2.B	P2.4	Ls
F	2.S	n.c.	
G	3.A	P3.5	Lp
H	3.B	P3.6	Lp
J	3.S	n.c.	
K	4.A	P4.7	Ls
L	4.B	P4.8	Ls
M	4.S	n.c.	
N	5.A	P5.1	Lp
P	5.B	P5.2	Lp
R	5.S	n.c.	
S	6.A	P6.1	Ls
T	6.B	P6.2	Ls
U	6.S	n.c.	

Cutting and Stripping phase
Data:
Operator: <i>Berni, Sposito</i>
Bobina di provenienza: <i>spezzoni</i>

Crimping and Labeling phase
Data:
Operator:
Tempo impiegato (ore):

Quality Control phase
Date:
Operator: <i>Berni</i>

Cleaning and Storage phase
Data:
Operatore/i:

Notes:

Diramare opportunamente, considerando che gli LVDT sono disposti a 120 gradi lungo i piedi dell'IP.

Cable Q (vacuum side)

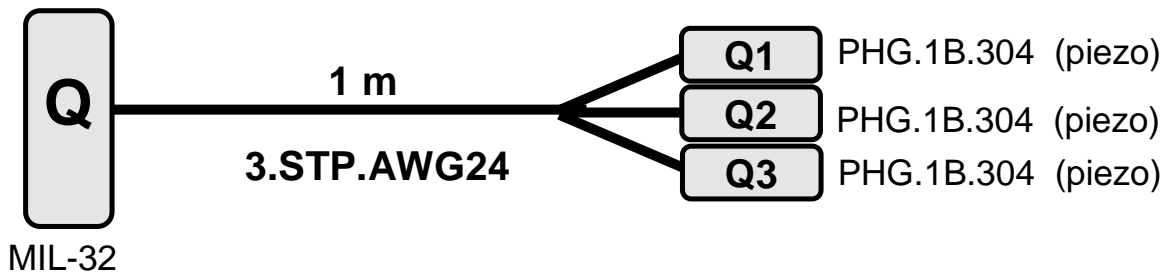

Cutting and Stripping phase
Data:
Operator: <i>Berni, Sposito</i>
Bobina di provenienza: <i>spezzoni</i>

Crimping and Labeling phase
Data:
Operator:
Tempo impiegato (ore):

Quality Control phase
Date:
Operator: <i>Berni</i>

Cleaning and Storage phase
Data:
Operatore/i:

Notes:
Creato per separare I piezo dagli LVDTs sul cavo P.

MIL-32 contacts	conductors	LEMO contacts	contact description
A			
B			
C			
D			
E			
F			
G			
H			
J			
K			
L			
M			
N			
P			
R			
S			
T			
U			
V	1.A	Q1.1	inner conductor
W	1.B	Q1.2	intermediate shield
X	1.S	Q1.3	outer shield
	n.c.	Q1.4	
Y	2.A	Q2.1	inner conductor
Z	2.B	Q2.2	intermediate shield
a	2.S	Q2.3	outer shield
	n.c.	Q2.4	
b	3.A	Q3.1	inner conductor
c	3.B	Q3.2	intermediate shield
d	3.S	Q3.3	outer shield
	n.c.	Q3.4	

cable R (vacuum side)

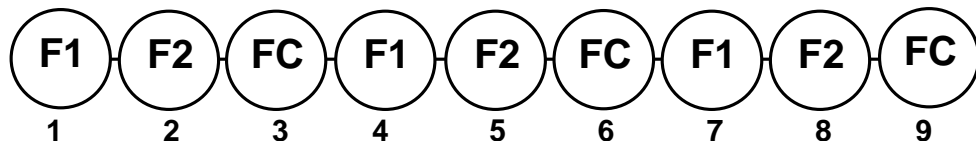
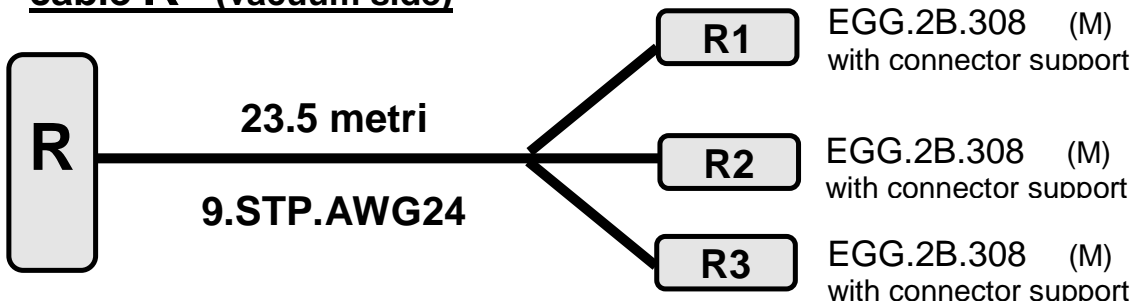

Cutting and Stripping phase
Date:
Operator: <i>F.Berni</i>
Reel: <i>vecchio cavo F</i>

Crimping and Labeling phase
Date:
Operator: <i>F.Berni</i>
Duration (hours):

Quality Control phase
Date:
Operator:

Cleaning and Storage phase
Date:
Operator:

Notes:
Modificato a maggio 2013 (scorciato e con Lemo da pannello, basato sul riutilizzo del vecchio cavo F). Per lo schema del vecchio cavo R vedere la versione v2.
NB: inserire il lemo da pannello nell'apposito clamp a C.
Diramare a <u>20</u> cm

MIL-32 contacts	conductors	LEMO contacts	contact description
A	1.A	R1.1	F1 +
B	1.B	R1.2	F1 -
C	1.S	n.c.	
D	2.A	R1.3	F2 +
E	2.B	R1.4	F2 -
F	2.S	n.c.	
G	3.A	R1.5	FC sx
H	3.B	R1.6	FC dx
J	3.S	R1.7	FC com
K	4.A	R2.1	F1 +
L	4.B	R2.2	F1 -
M	4.S	n.c.	
N	5.A	R2.3	F2 +
P	5.B	R2.4	F2 -
R	5.S	n.c.	
S	6.A	R2.5	FC sx
T	6.B	R2.6	FC dx
U	6.S	R2.7	FC com
V	7.A	R3.1	F1 +
W	7.B	R3.2	F1 -
X	7.S	n.c.	
Y	8.A	R3.3	F2 +
Z	8.B	R3.4	F2 -
a	8.S	n.c.	
b	9.A	R3.5	FC sx
c	9.B	R3.6	FC dx
d	9.S	R3.7	FC com

cable S (vacuum side)

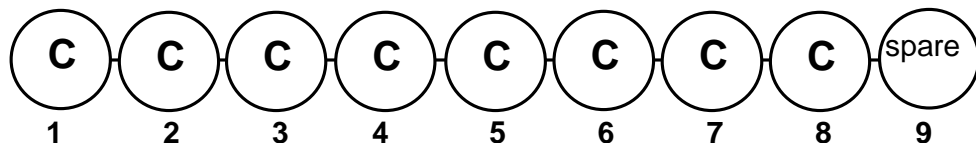
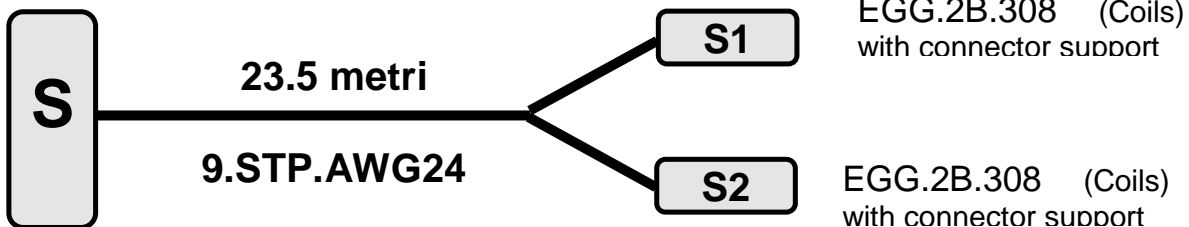

Cutting and Stripping phase
Date:
Operator: <i>F.Berni</i>
Reel: <i>vecchio cavo T</i>

Crimping and Labeling phase
Date:
Operator: : <i>F.Berni</i>
Duration (hours):

Quality Control phase
Date:
Operator:

Cleaning and Storage phase
Date:
Operator:

Notes:
Modificato a maggio 2013 (scorciato, messo Lemo da pannello, tolto ponticelli dal Mil-32 , usato vecchio cavo T). Per lo schema del vecchio cavo S vedere la versione v2.
NB: inserire il lemo da pannello nell'apposito clamp a C.
Diramare a <u>20 cm</u> ;

MIL-32 contacts	conductors	LEMO contacts	contact description
A	1.A	S1.1	C +
B	1.B	S1.2	C -
C	1.S	n.c.	
D	2.A	S1.3	C +
E	2.B	S1.4	C -
F	2.S	n.c.	
G	3.A	S1.5	C +
H	3.B	S1.6	C -
J	3.S	n.c.	
K	4.A	S1.7	C +
L	4.B	S1.8	C -
M	4.S	n.c.	
N	5.A	S2.1	C +
P	5.B	S2.2	C -
R	5.S	n.c.	
S	6.A	S2.3	C +
T	6.B	S2.4	C -
U	6.S	n.c.	
V	7.A	S2.5	C +
W	7.B	S2.6	C -
X	7.S	n.c.	
Y	8.A	S2.7	C +
Z	8.B	S2.8	C -
a	8.S	n.c.	
b	9.A		
c	9.B		
d	9.S		

cable T (vacuum side)

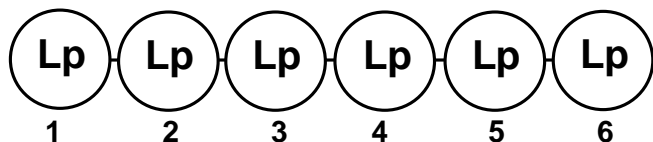
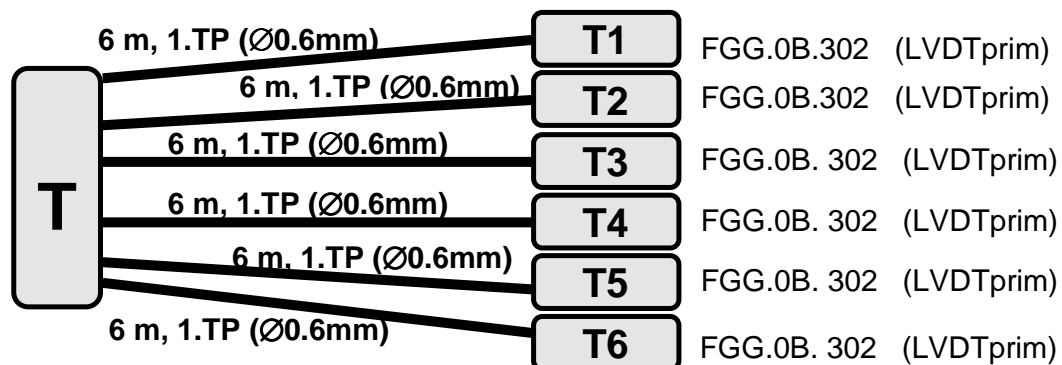

Cutting and Stripping phase
Date:
Operator: <i>F.Berni</i>
Reel: <i>Pyre-ML QML</i>

Crimping and Labeling phase
Date:
Operator: <i>F.Berni</i>
Duration (hours):

Quality Control phase
Date:
Operator: <i>Berni</i>

Cleaning and Storage phase
Date:
Operator: <i>Berni</i>

Notes:
It replaces the old cable T, made with a Gore cable (for the old scheme see version cable_schemes_v3). Rifatto a Nov2015 con filo UHV (Pyre-ML QML-quadruplo isolamento)

MIL-32 contacts	conductors	LEMO contacts	contact description
A	1.A	T1.1	Lp
B	1.B	T1.2	Lp
C	n.c.	n.c.	
D	2.A	T2.1	Lp
E	2.B	T2.2	Lp
F	n.c.	n.c.	
G	3.A	T3.1	Lp
H	3.B	T3.2	Lp
J	n.c.	n.c.	
K	4.A	T4.1	Lp
L	4.B	T4.2	Lp
M	n.c.	n.c.	
N	5.A	T5.1	Lp
P	5.B	T5.2	Lp
R	n.c.	n.c.	
S	6.A	T6.1	Lp
T	6.B	T6.2	Lp
U	n.c.	n.c.	
V			
W			
X			
Y			
Z			
a			
b			
c			
d			

cable U (vacuum side)

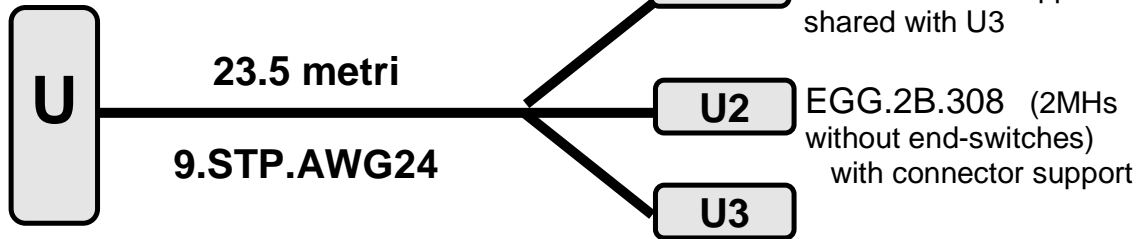

Cutting and Stripping phase
Date:
Operator: <i>Berni, Sposito</i>
Reel: <i>old cable of PR</i>

Crimping and Labeling phase
Date:
Operator: <i>Berni</i>
Duration (hours):

Quality Control phase
Date:
Operator:

Cleaning and Storage phase
Date:
Operator:

Notes:
NB: inserire i lemo da pannello negli appositi clamp a C. Diramare a 20 cm

MIL-32 contacts	conductors	LEMO contacts	contact description
A	1.A	U1.1	RH +
B	1.B	U1.2	RH -
C	1.S	n.c.	
D	2.A	U1.3	RH +
E	2.B	U1.4	RH -
F	2.S	n.c.	
G	3.A	U2.1	F1 +
H	3.B	U2.2	F1 -
J	3.S	n.c.	
K	4.A	U2.3	F2 +
L	4.B	U2.4	F2 -
M	4.S	n.c.	
N	5.A	U2.5	F1 +
P	5.B	U2.6	F1 -
R	5.S	n.c.	
S	6.A	U2.7	F2 +
T	6.B	U2.8	F2 -
U	6.S	n.c.	
V	7.A	U3.1	T voltmetric
W	7.B	U3.2	T voltmetric
X	7.S	n.c.	
Y	8.A	U3.3	spare
Z	8.B	U3.4	spare
a	8.S	n.c.	
b	9.A	U3.5	spare
c	9.B	U3.6	spare
d	9.S	n.c.	

cable V (vacuum side)

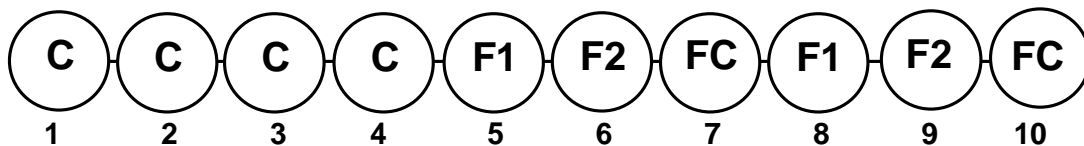
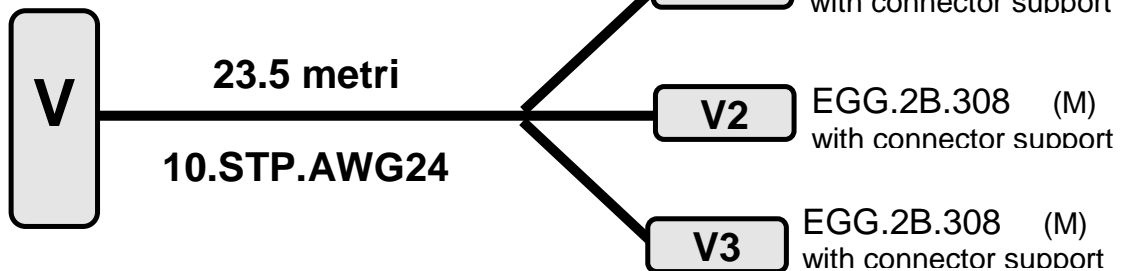

Cutting and Stripping phase
Date:
Operator: <i>F.Berni</i>
Reel: (primo lotto dei cavi di AdV)

Crimping and Labeling phase
Date:
Operator: <i>F.Berni</i>
Duration (hours):

Quality Control phase
Date:
Operator:

Cleaning and Storage phase
Date:
Operator:

Notes:
Rifatto ex-novo a maggio 2013. Per lo schema del vecchio cavo V vedere la versione v2.
NB: inserire il lemo da pannello nell'apposito clamp a C.
Diramare a 20 cm

MIL-32 contacts	conductors	LEMO contacts	contact description
A	1.A	V1.1	C +
B	1.B	V1.2	C -
C	1.S	n.c.	
D	2.A	V1.3	C +
E	2.B	V1.4	C -
F	2.S	n.c.	
G	3.A	V1.5	C +
H	3.B	V1.6	C -
J	3.S	n.c.	
K	4.A	V1.7	C +
L	4.B	V1.8	C -
M	4.S	n.c.	
N	5.A	V2.1	F1 +
P	5.B	V2.2	F1 -
R	5.S	n.c.	
S	6.A	V2.3	F2 +
T	6.B	V2.4	F2 -
U	6.S	n.c.	
V	7.A	V2.5	FC sx
W	7.B	V2.6	FC dx
X	7.S	V2.7	FC com
Y	8.A	V3.1	F1 +
Z	8.B	V3.2	F1 -
a	8.S	n.c.	
b	9.A	V3.3	F2 +
c	9.B	V3.4	F2 -
d	9.S	n.c.	
e	10.A	V3.5	FC sx
f	10.B	V3.6	FC dx
g	10.S	V3.7	FC com

cable W (vacuum side)

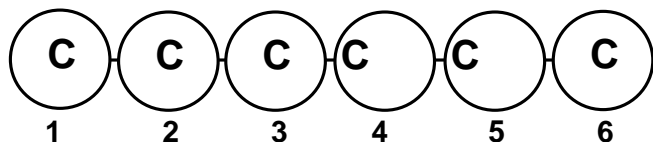
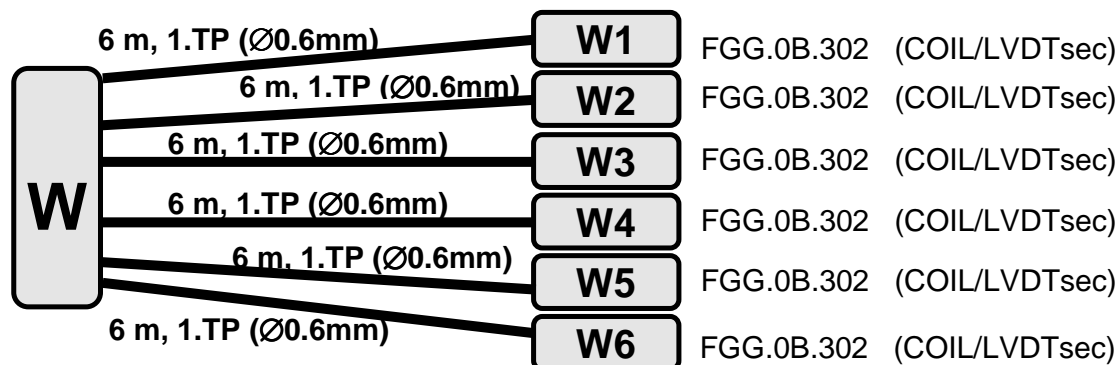

Cutting and Stripping phase
Date:
Operator: <i>F.Berni – G.Sposito</i>
Reel: <i>Pyre-ML QML</i>

Crimping and Labeling phase
Date:
Operator: <i>F.Berni</i>
Duration (hours):

Quality Control phase
Date:
Operator: <i>Berni</i>

Cleaning and Storage phase
Date:
Operator: <i>Berni</i>

Notes:
It replaces the old cable W, made with a Gore cable (for the old scheme see version cable_schemes_v3) Rifatto a Nov2015 con filo UHV (Pyre-ML QML-quadruplo isolamento)

MIL-32 contacts	conductors	LEMO contacts	contact description
A	1.A	W1.1	C +
B	1.B	W1.2	C -
C	n.c.	n.c.	
D	2.A	W2.1	C +
E	2.B	W2.2	C -
F	n.c.	n.c.	
G	3.A	W3.1	C +
H	3.B	W3.2	C -
J	n.c.	n.c.	
K	4.A	W4.1	C +
L	4.B	W4.2	C -
M	n.c.	n.c.	
N	5.A	W5.1	C +
P	5.B	W5.2	C -
R	n.c.	n.c.	
S	6.A	W6.1	C +
T	6.B	W6.2	C -
U	n.c.	n.c.	
V			
W			
X			
Y			
Z			
a			
b			
c			
d			

cable Z (Vacuum side)

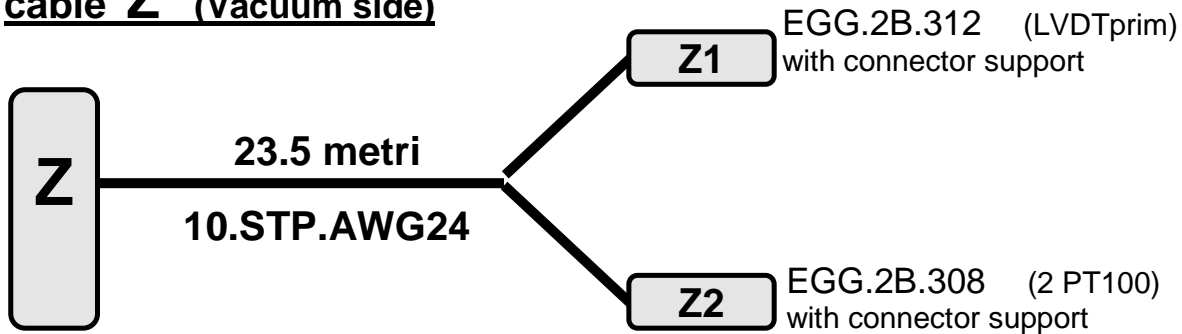

Cutting and Stripping phase
Date: <i>Nov 2015</i>
Operator: <i>Berni, Sposito</i>
Reel: <i>nuovo</i>

Crimping and Labeling phase
Date:
Operator:
Duration (hours):

Quality Control phase
Date:
Operator:

Cleaning and Storage phase
Date:
Operator:

Notes:
Nuovo, creato per AdV. Per collegare i primari degli attuatori/LVDT del F#. Usato anche per i sensori di temperatura del RH e del payload. NB: inserire il lemo da pannello nell'apposito clamp a C. Diramare a 20 cm

MIL-32 contacts	conductors	ODU / LEMO contacts	contact description
A	1.A	Z1.1	Lp
B	1.B	Z1.2	Lp
C	1.S	n.c.	
D	2.A	Z1.3	Lp
E	2.B	Z1.4	Lp
F	2.S	n.c.	
G	3.A	Z1.5	Lp
H	3.B	Z1.6	Lp
J	3.S	n.c.	
K	4.A	Z1.7	Lp
L	4.B	Z1.8	Lp
M	4.S	n.c.	
N	5.A	Z1.9	Lp
P	5.B	Z1.10	Lp
R	5.S	n.c.	
S	6.A	Z1.11	Lp
T	6.B	Z1.12	Lp
U	6.S	n.c.	
V	7.A	Z2.1	PT100 V+
W	7.B	Z2.2	PT100 V-
X	7.S	n.c.	
Y	8.A	Z2.3	PT100 A+
Z	8.B	Z2.4	PT100 A-
a	8.S	n.c.	
b	9.A	Z2.5	PT100 V+
c	9.B	Z2.6	PT100 V-
d	9.S	n.c.	
e	10.A	Z2.7	PT100 A+
f	10.B	Z2.8	PT100 A-
g	10.S	n.c.	

