

CABLE ASSEMBLY SCHEMES

for *Beam Splitter* cabling

Change History

Version	Date	Changes/Reasons	Authors
v1	Nov- Dec 1999	initial suspension cabling	Ceccanti, Dattilo
v2	Feb 2003	added cabling of sensors and actuators on Filter #7	Dattilo, Nenci
v3r0	Aug 2014	Modified cabling for allow new separating roof and new payload (cables F,R,S,T,V) and new F#7 actuation/sensing system (W). Cables U and X suppressed. No more tiltmeters on F#7, more devices on payload.	Berni, Dattilo, Gherardini
v3r1	Oct 2014	Added cables T and Z for connection of LVDT primaries of Filter #7. Adopted the CW and CCW notation for the motor end switches (previous was FW and BW, but was resulting a bit ambiguous)	Berni, Dattilo, Gherardini
v3r1p1	3nov14	-Change in cable N due to a damage on STP1 - Cable P has been split into cable P and cable Q after request of A.Gennai of keeping piezos and LVDTs on 2 separate feedthroughs.	Berni, Dattilo, Gherardini

Contents

CABLE ASSEMBLY SCHEMES FOR BEAM SPLITTER CABLING.....	1
CHANGE HISTORY	1
IDENTIFICAZIONE COMPONENTI.....	2
LEGENDA	3
LEMO PINOUT OF THE MAIN DEVICES	3
CABLE A (VACUUM SIDE)	5
CABLE B (VACUUM SIDE).....	6
CABLE C (VACUUM SIDE)	7
CABLE D (VACUUM SIDE)	8
CABLE E (VACUUM SIDE).....	9
CABLE F (VACUUM SIDE).....	10
CABLE G (VACUUM SIDE).....	11
CABLE H (VACUUM SIDE).....	12
CABLE J (VACUUM SIDE)	13
CABLE K (VACUUM SIDE).....	14
CABLE L (VACUUM SIDE).....	15
CABLE M (VACUUM SIDE)	16
CABLE N (VACUUM SIDE)	17
CABLE O (VACUUM SIDE).....	18
CABLE P (VACUUM SIDE).....	19
CABLE Q (VACUUM SIDE).....	20
CABLE R (VACUUM SIDE)	21
CABLE S (VACUUM SIDE).....	22
CABLE T (VACUUM SIDE).....	23
CABLE V (VACUUM SIDE)	24
CABLE W (VACUUM SIDE)	25
CABLE Z (VACUUM SIDE).....	26

Informazioni generali

Ciascun spezzone di cavo va terminato ad una estremità da un connettore circolare 32 poli (tipo presa, con sockets), all'altra estremità con uno o più connettori Lemo multipolari (generalmente tipo spina, con pins). I cavi sono del tipo:

- cavo piatto a 18 o 20 conduttori AWG 24 a coppie intrecciate e schermate singolarmente (cavo STP).
- cavo assemblato in lab a conduttori solidi AWG 18 o AWG 24, isolati in polimide, a coppie ritorte (cavo TP).
-

Identificazione componenti

- Ciascun cavo è identificato da una lettera dell'alfabeto.
- Il tipo di cavo utilizzato e' indicato in prossimità del disegno: la sigla comprende il numero di coppie di conduttori, il tipo di schermatura (STP), la sezione (AWG24). Es.: la sigla **9.STP.AWG24** specifica un tipo di cavo avente 18 conduttori intrecciati e schermati a coppie, di sezione AWG24
- Ciascun conduttore di un cavo STP è identificato da un numero cardinale relativo alla coppia (**1** per la coppia bianco/rossa a seguire fino ad **9** per le altre coppie bianco/gialle), da una lettera (**A** per il conduttore con isolante a strisce rosse, **B** per l'altro conduttore della coppia, **S** per la calza) (es. la calza nella terza coppia, è identificata da **3.S**).
- Ciascun connettore Lemo è identificato da due caratteri: il primo è la lettera del cavo sul quale è saldato il connettore, il secondo è un numero cardinale, che va da 1 al n. max di connettori Lemo sullo stesso cavo (es. per il cavo **B** terminato da due Lemo, essi sono identificati da **B1** e **B2**)
- I contatti di ciascun connettore Lemo sono identificati dal nome del connettore, seguito dal numero del contatto indicato sull'isolante del connettore (es. il contatto¹ n. 4 che si trova sul connettore Lemo **B3** e' identificato da **B3.4**)
- I contatti di ciascun connettore circolare a 32 poli sono identificati da lettere (A÷Z, a÷j). Per quelli interni vale il pinout serigrafato sul retro dell'isolante, per quelli esterni vale il pinout standard

¹ Nel caso di conduttori Lemo, il contatto n. 1 e' quello col semicerchio bianco, i successivi sono quelli lungo la linea bianca che parte dal contatto n. 1.

Legenda

F1 +	motore, fase 1, positivo
F1 -	motore, fase 1, negativo
F2 +	motore, fase 2, positivo
F2 -	motore, fase 2, negativo
FC cw	motore, fine corsa che si incontra quando l'albero gira <u>in senso orario</u> per un osservatore coincidente con il motore
FC ccw	motore, fine corsa che si incontra quando l'albero gira <u>in senso antiorario</u> per un osservatore coincidente con il motore
FC com	motore, fine corsa, comune
RST up	motore, reostato, terminale superiore
RST down	motore, reostato, terminale inferiore
RST com	motore, reostato, comune o cursore
TP sx +	thermal probe, sinistro, positivo
TP sx -	thermal probe, sinistro, negativo
TP dx +	thermal probe, destro, positivo
TP dx -	thermal probe, destro, negativo
Ls	LVDT, secondario
Lp	LVDT, primario
C +	coil attuatore, positivo
C -	coil attuatore, negativo
fbk	accelerometro, feedback
V _H	Voltmetrico alto
V _L	Voltmetrico basso
A _H	Amperometrico alto
A _L	Amperometrico basso

LEMO pinout of the main devices

ACCELEROMETER	
LEMO contacts	Contact descript.
1	Lp
2	Lp
3	
4	F1 +
5	F1 -
6	F2 +
7	F2 -
8	
9	FC sx
11	FC dx
10	FC com
12	fbk
13	fbk
14	
15	Ls
16	Ls
17	
18	

LVDT	
LEMO contacts	Contact descript.
1	Lp +
2	Lp -
3	Ls +
4	Ls -

COIL	
LEMO contacts	Contact descript.
1	C +
2	C -

MOTOR		
LEMO contacts	Contact descript.	UTG 12p contacts
1	F1 +	A
2	F1 -	B
3	F1 shield	C
4	F2 +	D
	F2 -	E
	F2 shield	F
5	FC cw	G
6	FC ccw	H
7	FC com	J
8	n.c.	

cable A (vacuum side)

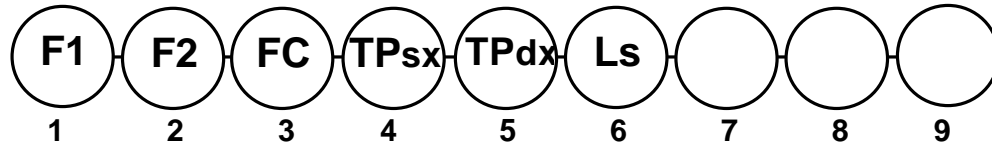
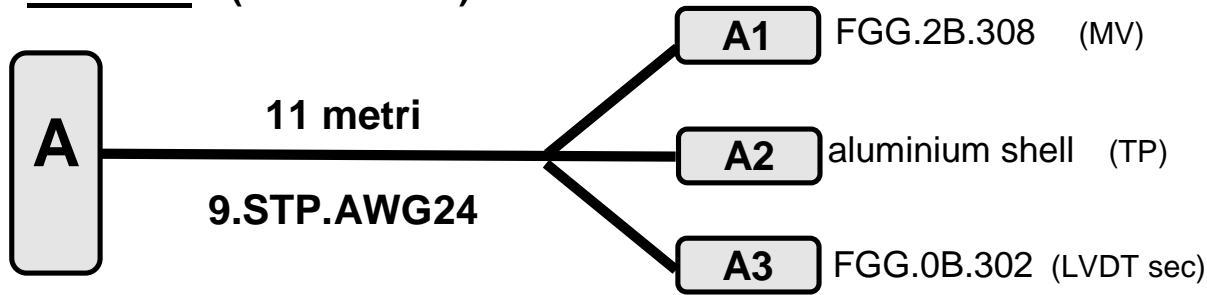

Cutting and Stripping phase
Date: 9 dec 99
Operator: M. Ceccanti
Reel:

Crimping and Labeling phase
Date: 9 dec 99
Operator: M. Ceccanti
Duration (hours): 3

Quality Control phase
Date: 13 jan 00
Operator: M. Ceccanti

Cleaning and Storage phase
Date: 20 dec 99
Operator: M. Ceccanti

Notes:
Diramare a 60 cm

MIL-32 contacts	conductors	LEMO contacts	contact description
A	1.A	A1.1	F1 +
B	1.B	A1.2	F1 -
C	1.S	n.c.	
D	2.A	A1.3	F2 +
E	2.B	A1.4	F2 -
F	2.S	n.c.	
G	3.A	A1.5	FC cw
H	3.B	A1.6	FC ccw
J	3.S	A1.7	FC com
K	4.A	A2	TP sx +
L	4.B	A2	TP sx -
M	4.S	n.c.	
N	5.A	A2	TP dx +
P	5.B	A2	TP dx -
R	5.S	n.c.	
S	6.A	A3.1	Ls
T	6.B	A3.2	Ls
U	6.S	n.c.	
V	7.A		
W	7.B		
X	7.S		
Y	8.A		
Z	8.B		
a	8.S		
b	9.A		
c	9.B		
d	9.S		

cable B (vacuum side)

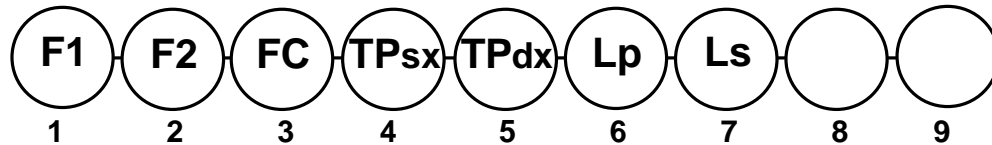
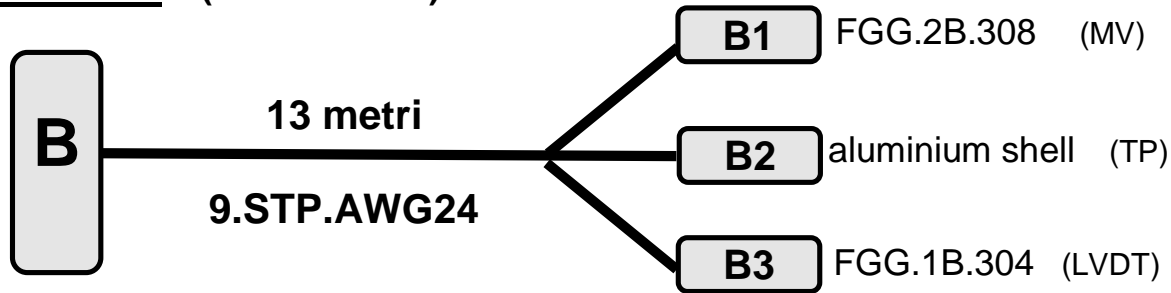

Cutting and Stripping phase
Date: 7 dec 99
Operator: M. Ceccanti
Reel:

Crimping and Labeling phase
Date: 7 dec 99
Operator: M. Ceccanti
Duration (hours): 3

Quality Control phase
Date: 13 jan 00
Operator: M. Ceccanti

Cleaning and Storage phase
Date: 20 dec 99
Operator: M. Ceccanti

Notes:
Diramare a 60 cm

MIL-32	conductors	LEMO	contact
--------	------------	------	---------

contacts		contacts	description
A	1.A	B1.1	F1 +
B	1.B	B1.2	F1 -
C	1.S	n.c.	
D	2.A	B1.3	F2 +
E	2.B	B1.4	F2 -
F	2.S	n.c.	
G	3.A	B1.5	FC cw
H	3.B	B1.6	FC ccw
J	3.S	B1.7	FC com
K	4.A	B2	TP sx +
L	4.B	B2	TP sx -
M	4.S	n.c.	
N	5.A	B2	TP dx +
P	5.B	B2	TP dx -
R	5.S	n.c.	
S	6.A	B3.1	Lp
T	6.B	B3.2	Lp
U	6.S	n.c.	
V	7.A	B3.3	Ls
W	7.B	B3.4	Ls
X	7.S	n.c.	
Y	8.A		
Z	8.B		
a	8.S		
b	9.A		
c	9.B		
d	9.S		

cable C (vacuum side)

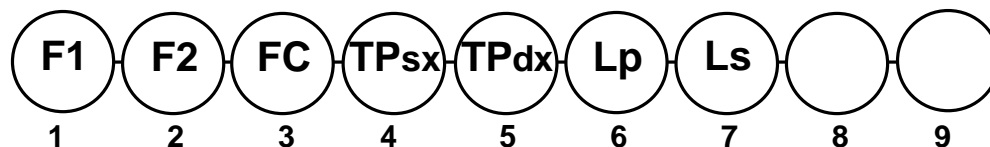
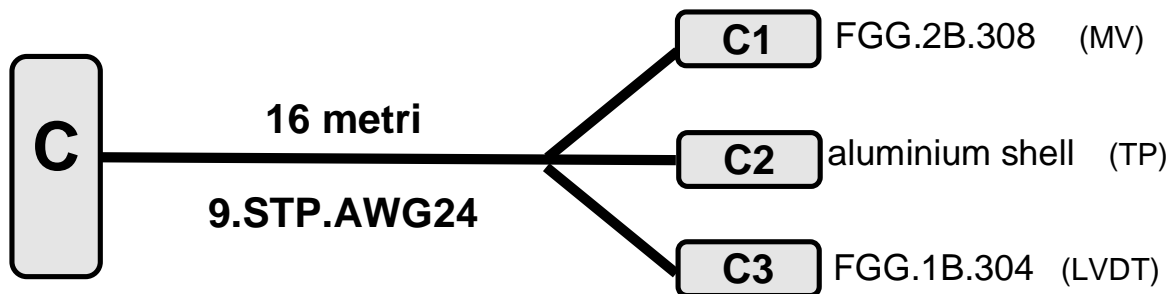

Cutting and Stripping phase
Date: 7 dec 99
Operator: M. Ceccanti
Reel:

Crimping and Labeling phase
Date: 7 dec 99
Operator: M. Ceccanti
Duration (hours): 2.5

Quality Control phase
Date: 13 jan 00
Operator: M. Ceccanti

Cleaning and Storage phase
Date: 20 dec 99
Operator: M. Ceccanti

Notes:
Diramare a 60 cm

MIL-32 contacts	conductors	LEMO contacts	contact description
A	1.A	C1.1	F1 +
B	1.B	C1.2	F1 -
C	1.S	n.c.	
D	2.A	C1.3	F2 +
E	2.B	C1.4	F2 -
F	2.S	n.c.	
G	3.A	C1.5	FC cw
H	3.B	C1.6	FC ccw
J	3.S	C1.7	FC com
K	4.A	C2	TP sx +
L	4.B	C2	TP sx -
M	4.S	n.c.	
N	5.A	C2	TP dx +
P	5.B	C2	TP dx -
R	5.S	n.c.	
S	6.A	C3.1	Lp
T	6.B	C3.2	Lp
U	6.S	n.c.	
V	7.A	C3.3	Ls
W	7.B	C3.4	Ls
X	7.S	n.c.	
Y	8.A		
Z	8.B		
a	8.S		
b	9.A		
c	9.B		
d	9.S		

cable D (vacuum side)

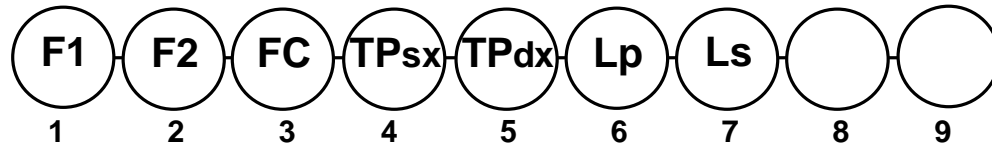
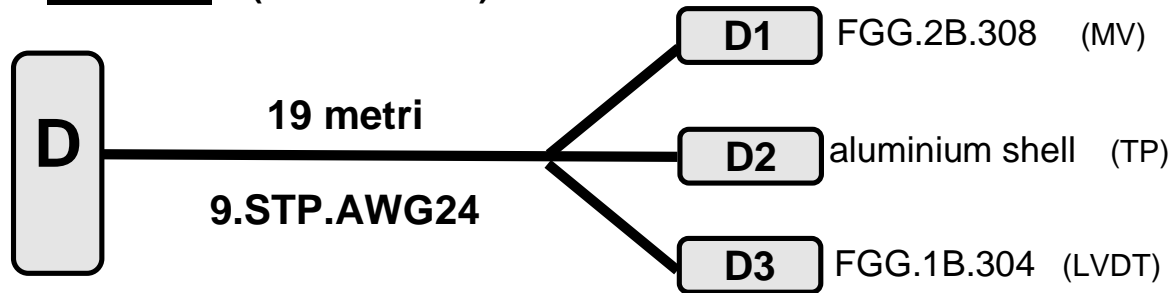

Cutting and Stripping phase
Date: 2 dec 99
Operator: M. Ceccanti
Reel:

Crimping and Labeling phase
Date: 2 dec 99
Operator: M. Ceccanti
Duration (hours): 3

Quality Control phase
Date: 13 jan 00
Operator: M. Ceccanti

Cleaning and Storage phase
Date: 20 dec 99
Operator: M. Ceccanti

Notes:
Diramare a 60 cm

MIL-32 contacts	conductors	LEMO contacts	contact description
A	1.A	D1.1	F1 +
B	1.B	D1.2	F1 -
C	1.S	n.c.	
D	2.A	D1.3	F2 +
E	2.B	D1.4	F2 -
F	2.S	n.c.	
G	3.A	D1.5	FC cw
H	3.B	D1.6	FC ccw
J	3.S	D1.7	FC com
K	4.A	D2	TP sx +
L	4.B	D2	TP sx -
M	4.S	n.c.	
N	5.A	D2	TP dx +
P	5.B	D2	TP dx -
R	5.S	n.c.	
S	6.A	D3.1	Lp
T	6.B	D3.2	Lp
U	6.S	n.c.	
V	7.A	D3.3	Ls
W	7.B	D3.4	Ls
X	7.S	n.c.	
Y	8.A		
Z	8.B		
a	8.S		
b	9.A		
c	9.B		
d	9.S		

cable E (vacuum side)

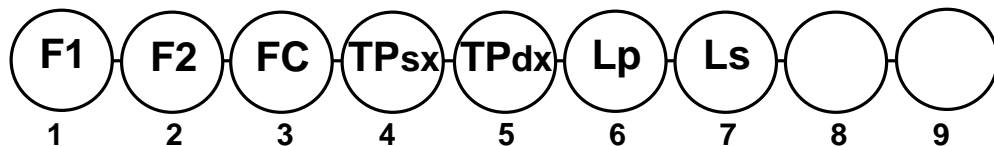
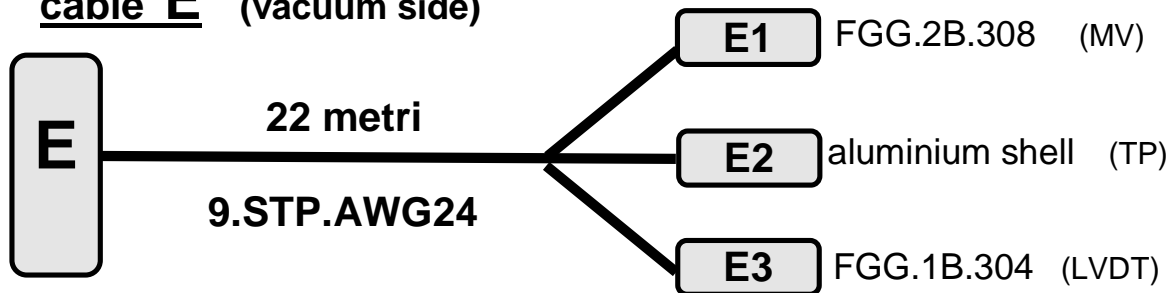

Cutting and Stripping phase
Date: 3 dec 99
Operator: M. Ceccanti
Reel:

Crimping and Labeling phase
Date: 3 dec 99
Operator: M. Ceccanti
Duration (hours): 3

Quality Control phase
Date: 13 jan 00
Operator: M. Ceccanti

Cleaning and Storage phase
Date: 20 dec 99
Operator: M. Ceccanti

Notes:
Diramare a 60 cm

MIL-32 contacts	conductors	LEMO contacts	contact description
A	1.A	E1.1	F1 +
B	1.B	E1.2	F1 -
C	1.S	n.c.	
D	2.A	E1.3	F2 +
E	2.B	E1.4	F2 -
F	2.S	n.c.	
G	3.A	E1.5	FC cw
H	3.B	E1.6	FC ccw
J	3.S	E1.7	FC com
K	4.A	E2	TP sx +
L	4.B	E2	TP sx -
M	4.S	n.c.	
N	5.A	E2	TP dx +
P	5.B	E2	TP dx -
R	5.S	n.c.	
S	6.A	E3.1	Lp
T	6.B	E3.2	Lp
U	6.S	n.c.	
V	7.A	E3.3	Ls
W	7.B	E3.4	Ls
X	7.S	n.c.	
Y	8.A		
Z	8.B		
a	8.S		
b	9.A		
c	9.B		
d	9.S		

cable F (vacuum side)

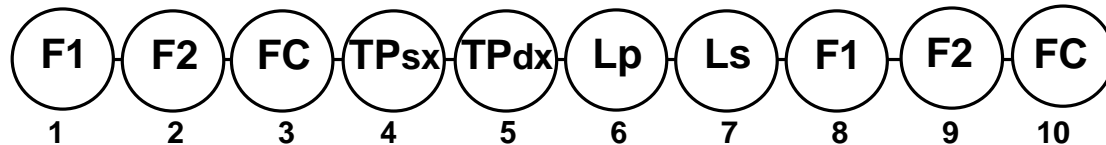
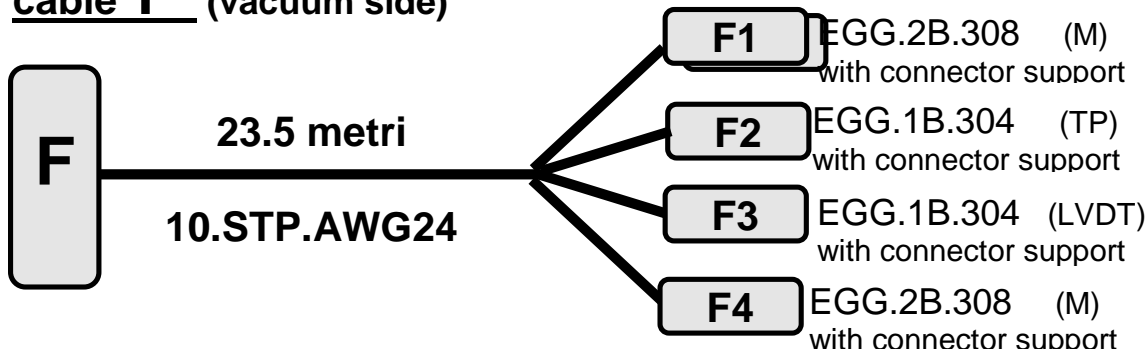

Cutting and Stripping phase
Date:
Operator: <i>F.Berni</i>
Reel: 11 (21956717-2)

Crimping and Labeling phase
Date:
Operator: <i>F.Berni</i>
Duration (hours):

Quality Control phase
Date: <i>12aug14</i>
Operator: <i>F.Berni</i>

Cleaning and Storage phase
Date:
Operator:

Notes:
Rifatto ex-novo ad agosto 2014. Per lo schema del vecchio cavo F vedere la versione v2.
NB: inserire il lemo da pannello nell'apposito clamp a C.
Diramare a 30 cm

MIL-32 contacts	conductors	LEMO contacts	contact description
A	1.A	F1.1	F1 +
B	1.B	F1.2	F1 -
C	1.S	n.c.	
D	2.A	F1.3	F2 +
E	2.B	F1.4	F2 -
F	2.S	n.c.	
G	3.A	F1.5	FC cw
H	3.B	F1.6	FC ccw
J	3.S	F1.7	FC com
K	4.A	F2.1	TP sx +
L	4.B	F2.2	TP sx -
M	4.S	n.c.	
N	5.A	F2.3	TP dx +
P	5.B	F2.4	TP dx -
R	5.S	n.c.	
S	6.A	F3.1	Lp
T	6.B	F3.2	Lp
U	6.S	n.c.	
V	7.A	F3.3	Ls
W	7.B	F3.4	Ls
X	7.S	n.c.	
Y	8.A	F4.1	F1 +
Z	8.B	F4.2	F1 -
a	8.S	n.c.	
b	9.A	F4.3	F2 +
c	9.B	F4.4	F2 -
d	9.S	n.c.	
e	10.A	F4.5	FC cw
f	10.B	F4.6	FC ccw
g	10.S	F4.7	FC com

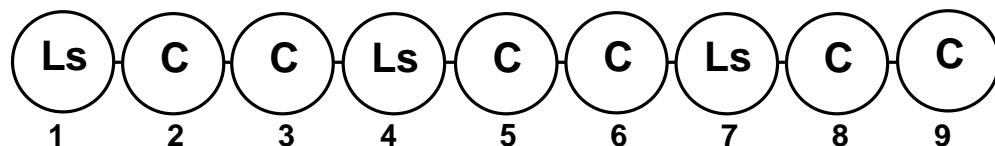
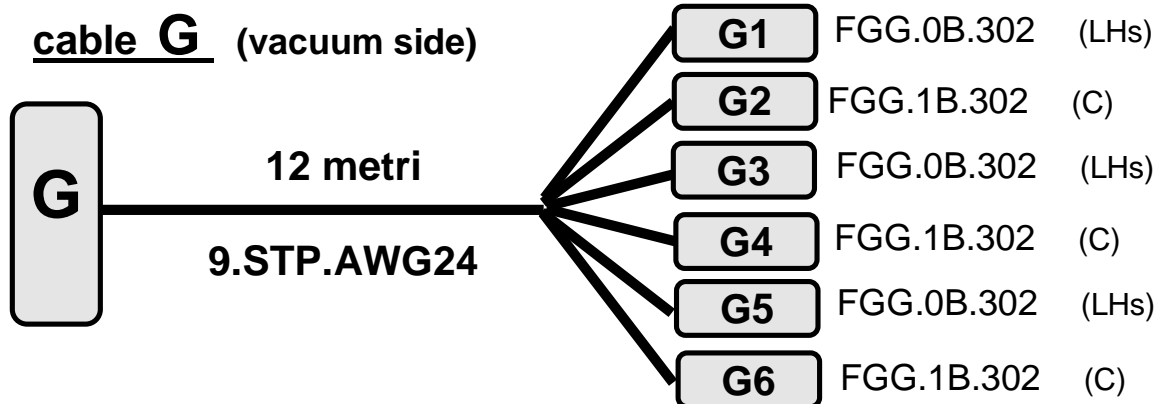

Cutting and Stripping phase
Date: 10 dec 99
Operator: M. Ceccanti
Reel:

Crimping and Labeling phase
Date: 10 dec 99
Operator: M. Ceccanti
Duration (hours): 2.5

Quality Control phase
Date: 13 jan 00
Operator: M. Ceccanti

Cleaning and Storage phase
Date: 20 dec 99
Operator: M. Ceccanti

Notes:
 Diramare a 2,3 metri.
 Scorciare G3+G4 di 1.5 metri rispetto ai 12 metri totali.
I ponticelli su MIL-32 erano già presenti sulla versione v2, anche se non riportati.

MIL-32 contacts	conductors	LEMO contacts	contact description
A	1.A	G1.1	Ls
B	1.B	G1.2	Ls
C	1.S	n.c.	
D	2.A	G2.1	C +
E	2.B	G2.2	C -
F	2.S	n.c.	
G	3.A	G2.1	C +
H	3.B	G2.2	C -
J	3.S	n.c.	
K	4.A	G3.1	Ls
L	4.B	G3.2	Ls
M	4.S	n.c.	
N	5.A	G4.1	C +
P	5.B	G4.2	C -
R	5.S	n.c.	
S	6.A	G4.1	C +
T	6.B	G4.2	C -
U	6.S	n.c.	
V	7.A	G5.1	Ls
W	7.B	G5.2	Ls
X	7.S	n.c.	
Y	8.A	G6.1	C +
Z	8.B	G6.2	C -
a	8.S	n.c.	
b	9.A	G6.1	C +
c	9.B	G6.2	C -
d	9.S	n.c.	

cable H (vacuum side)

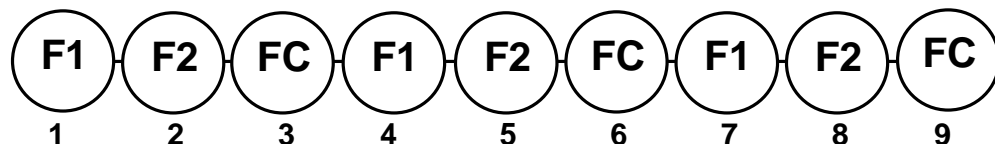
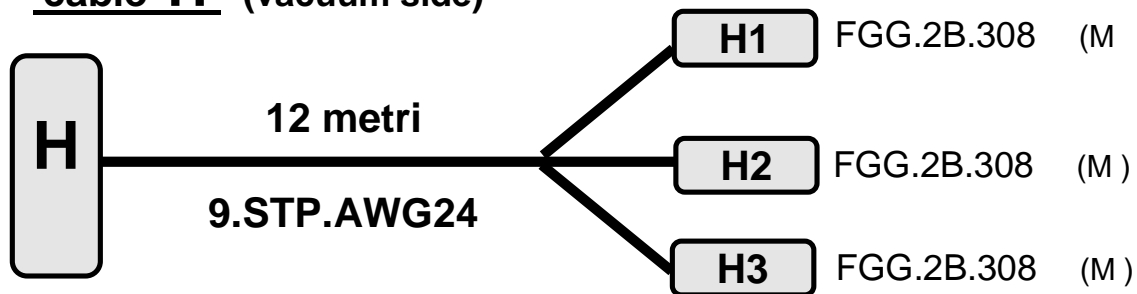

Cutting and Stripping phase
Date: 9 dec 99
Operator: M. Ceccanti
Reel:

Crimping and Labeling phase
Date: 9 dec 99
Operator: M. Ceccanti
Duration (hours): 2.5

Quality Control phase
Date: 13 jan 00
Operator: M. Ceccanti

Cleaning and Storage phase
Date: 20 dec 99
Operator: M. Ceccanti

Notes:
 Diramare a 40 cm

MIL-32 contacts	conductors	LEMO contacts	contact description
A	1.A	H1.1	F1 +
B	1.B	H1.2	F1 -
C	1.S	n.c.	
D	2.A	H1.3	F2 +
E	2.B	H1.4	F2 -
F	2.S	n.c.	
G	3.A	H1.5	FC cw
H	3.B	H1.6	FC ccw
J	3.S	H1.7	FC com
K	4.A	H2.1	F1 +
L	4.B	H2.2	F1 -
M	4.S	n.c.	
N	5.A	H2.3	F2 +
P	5.B	H2.4	F2 -
H	5.S	n.c.	
S	6.A	H2.5	FC cw
T	6.B	H2.6	FC ccw
U	6.S	H2.7	FC com
V	7.A	H3.1	F1 +
W	7.B	H3.2	F1 -
X	7.S	n.c.	
Y	8.A	H3.3	F2 +
Z	8.B	H3.4	F2 -
a	8.S	n.c.	
b	9.A	H3.5	FC cw
c	9.B	H3.6	FC ccw
d	9.S	H3.7	FC com

cable J (vacuum side)

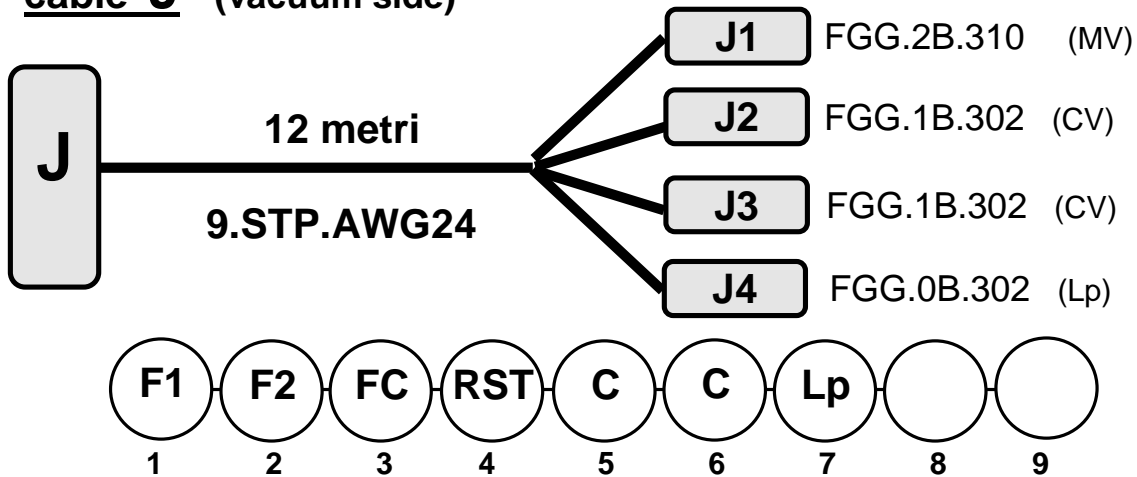

Cutting and Stripping phase

Date: 10 dec 99

Operator: M. Ceccanti

Reel:

Crimping and Labeling phase

Date: 10 dec 99

Operator: M. Ceccanti

Duration (hours): 3

Quality Control phase

Date: 13 jan 00

Operator: M. Ceccanti

Cleaning and Storage phase

Date: 20 dec 99

Operator: M. Ceccanti

Notes:

Diramare a 100 cm J2 e (J3+J4)

J1 piu' corto di 100 cm

J2 piu' corto di 100 cm.

RST e' il reostato, usato come sensore di posizione dell'hoist.

MIL-32 contacts	conductors	LEMO contacts	contact description
A	1.A	J1.1	F1 +
B	1.B	J1.2	F1 -
C	1.S	n.c.	
D	2.A	J1.3	F2 +
E	2.B	J1.4	F2 -
F	2.S	n.c.	
G	3.A	J1.5	FC cw
H	3.B	J1.6	FC ccw
J	3.S	J1.7	FC com
K	4.A	J1.8	RST
L	4.B	J1.9	RST
M	4.S	J1.10	RST com
N	5.A	J2.1	C+
P	5.B	J2.2	C-
R	5.S	n.c.	
S	6.A	J3.1	C+
T	6.B	J3.2	C-
U	6.S	n.c.	
V	7.A	J4.1	Lp
W	7.B	J4.2	Lp
X	7.S	n.c.	
Y	8.A		
Z	8.B		
a	8.S		
b	9.A		
c	9.B		
d	9.S		

cable K (vacuum side)

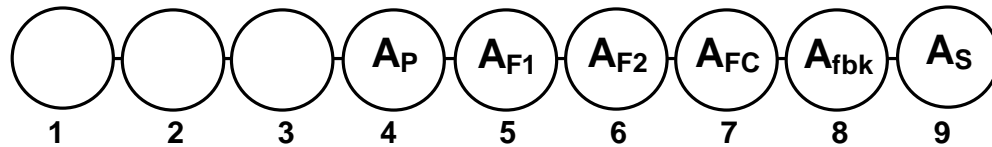
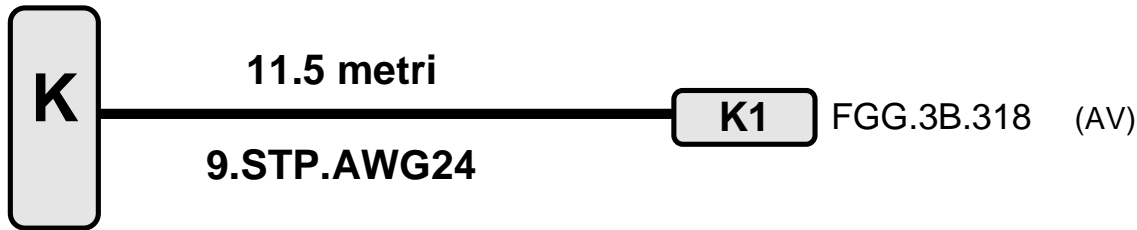

Cutting and Stripping phase
Date: 10 dec 99
Operator: M. Ceccanti
Reel:

Crimping and Labeling phase
Date: 10 dec 99
Operator: M. Ceccanti
Duration (hours): 2.5

Quality Control phase
Date: 13 jan 00
Operator: M. Ceccanti

Cleaning and Storage phase
Date: 20 dec 99
Operator: M. Ceccanti

Notes:

MIL-32 contacts	conductors	LEMO contacts	contact description
A	1.A		
B	1.B		
C	1.S		
D	2.A		
E	2.B		
F	2.S		
G	3.A		
H	3.B		
J	3.S		
K	4.A	K1.1	Lp
L	4.B	K1.2	Lp
M	4.S	K1.3	
N	5.A	K1.4	F1 +
P	5.B	K1.5	F1 -
R	5.S	K1.8	
S	6.A	K1.6	F2 +
T	6.B	K1.7	F2 -
U	6.S	K1.18	
V	7.A	K1.9	FC cw
W	7.B	K1.11	FC ccw
X	7.S	K1.10	FC com
Y	8.A	K1.12	fbk
Z	8.B	K1.13	fbk
a	8.S	K1.14	
b	9.A	K1.15	Ls
c	9.B	K1.16	Ls
d	9.S	K1.17	

cable L (vacuum side)

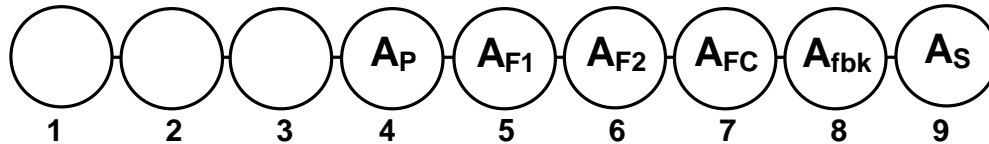
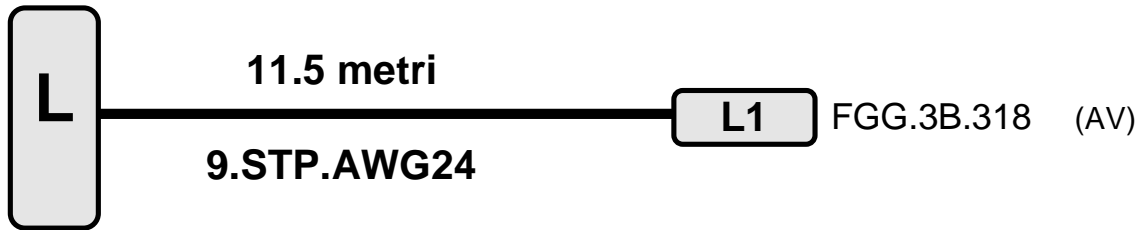

Cutting and Stripping phase
Date: 13 dec 99
Operator: M. Ceccanti
Reel:

Crimping and Labeling phase
Date: 13 dec 99
Operator: M. Ceccanti
Duration (hours): 3

Quality Control phase
Date: 13 jan 00
Operator: M. Ceccanti

Cleaning and Storage phase
Date: 20 dec 99
Operator: M. Ceccanti

Notes:

MIL-32 contacts	conductors	LEMO contacts	contact description
A	1.A		
B	1.B		
C	1.S		
D	2.A		
E	2.B		
F	2.S		
G	3.A		
H	3.B		
J	3.S		
K	4.A	L1.1	Lp
L	4.B	L1.2	Lp
M	4.S	L1.3	
N	5.A	L1.4	F1 +
P	5.B	L1.5	F1 -
R	5.S	L1.8	
S	6.A	L1.6	F2 +
T	6.B	L1.7	F2 -
U	6.S	L1.18	
V	7.A	L1.9	FC cw
W	7.B	L1.11	FC ccw
X	7.S	L1.10	FC com
Y	8.A	L1.12	fbk
Z	8.B	L1.13	fbk
a	8.S	L1.14	
b	9.A	L1.15	Ls
c	9.B	L1.16	Ls
d	9.S	L1.17	

cable M (vacuum side)

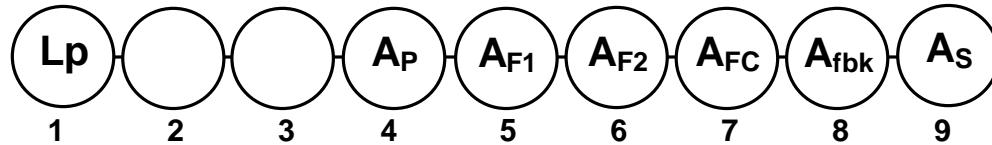
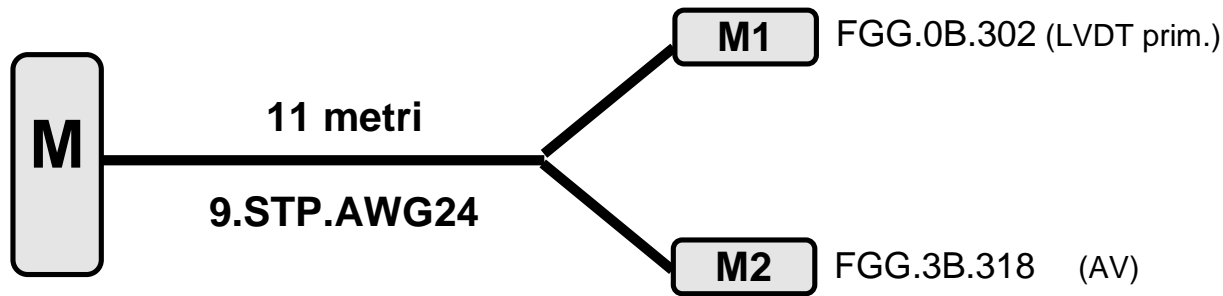

Cutting and Stripping phase
Date: 13 dec 99
Operator: M. Ceccanti
Reel:

Crimping and Labeling phase
Date: 13 dec 99
Operator: M. Ceccanti
Duration (hours): 3

Quality Control phase
Date: 13 jan 00
Operator: M. Ceccanti

Cleaning and Storage phase
Date: 20 dec 99
Operator: M. Ceccanti

Notes:
Diramare a 60 cm

MIL-32 contacts	conductors	LEMO contacts	contact description
A	1.A	M1.1	Lp
B	1.B	M1.2	Lp
C	1.S	n.c.	
D	2.A		
E	2.B		
F	2.S		
G	3.A		
H	3.B		
J	3.S		
K	4.A	M2.1	Lp
L	4.B	M2.2	Lp
M	4.S	M2.3	
N	5.A	M2.4	F1 +
P	5.B	M2.5	F1 -
R	5.S	M2.8	
S	6.A	M2.6	F2 +
T	6.B	M2.7	F2 -
U	6.S	M2.18	
V	7.A	M2.9	FC cw
W	7.B	M2.11	FC ccw
X	7.S	M2.10	FC com
Y	8.A	M2.12	fbk
Z	8.B	M2.13	fbk
a	8.S	M2.14	
b	9.A	M2.15	Ls
c	9.B	M2.16	Ls
d	9.S	M2.17	

cable N (vacuum side)

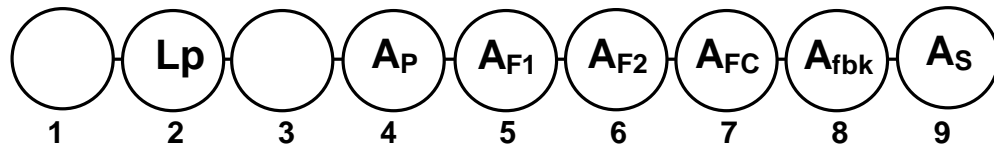
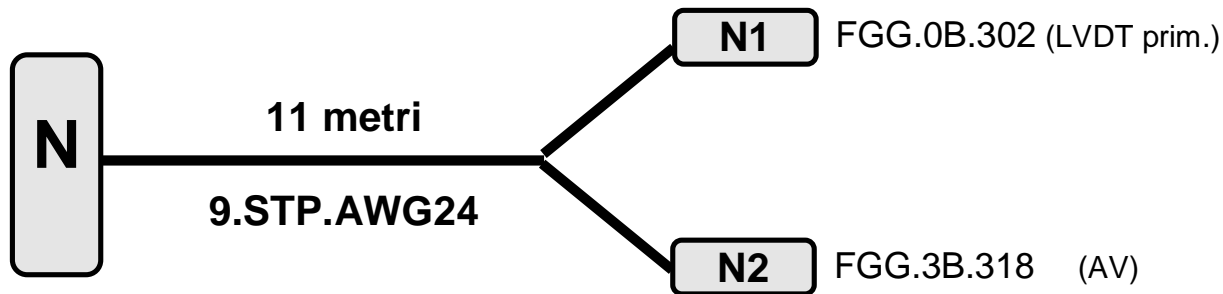

Cutting and Stripping phase
Date: 14 dec 99
Operator: M. Ceccanti
Reel:

Crimping and Labeling phase
Date: 14 dec 99
Operator: M. Ceccanti
Duration (hours): 3

Quality Control phase
Date: 13 jan 00
Operator: M. Ceccanti

Cleaning and Storage phase
Date: 20 dec 99
Operator: M. Ceccanti

Notes:
Diramato a 40 cm
- oct2014: riparato da Berni e Gherardini: in seguito a danno su STP1, spostato N1 su STP2

MIL-32 contacts	conductors	LEMO contacts	contact description
A	1.A		
B	1.B		
C	1.S		
D	2.A	N1.1	Lp
E	2.B	N1.2	Lp
F	2.S	n.c.	
G	3.A		
H	3.B		
J	3.S		
K	4.A	N2.1	Lp
L	4.B	N2.2	Lp
M	4.S	N2.3	
N	5.A	N2.4	F1 +
P	5.B	N2.5	F1 -
R	5.S	N2.8	
S	6.A	N2.6	F2 +
T	6.B	N2.7	F2 -
U	6.S	N2.18	
V	7.A	N2.9	FC cw
W	7.B	N2.11	FC ccw
X	7.S	N2.10	FC com
Y	8.A	N2.12	fbk
Z	8.B	N2.13	fbk
a	8.S	N2.14	
b	9.A	N2.15	Ls
c	9.B	N2.16	Ls
d	9.S	N2.17	

cable O (vacuum side)

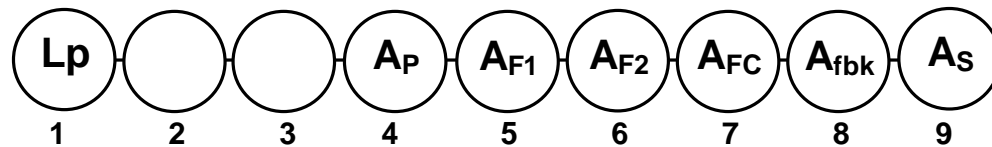
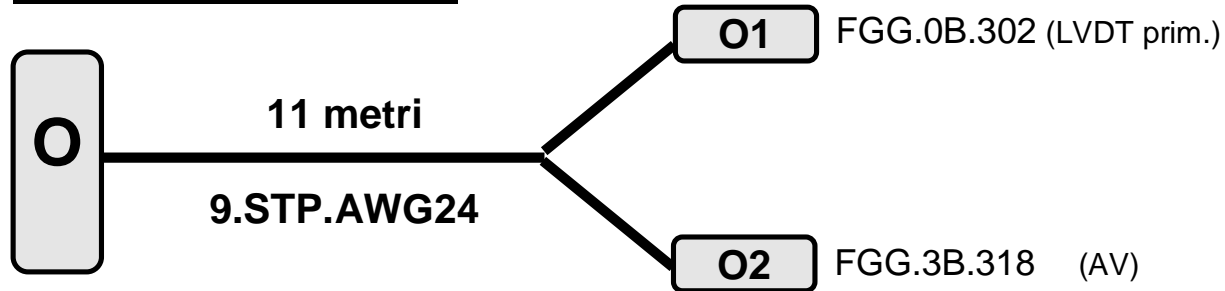

Cutting and Stripping phase
Date: 14 dec 99
Operator: M. Ceccanti
Reel:

Crimping and Labeling phase
Date: 14 dec 99
Operator: M. Ceccanti
Duration (hours): 3

Quality Control phase
Date: 13 jan 00
Operator: M. Ceccanti

Cleaning and Storage phase
Date: 20 dec 99
Operator: M. Ceccanti

Notes:

MIL-32 contacts	conductors	LEMO contacts	contact description
A	1.A	O1.1	Lp
B	1.B	O1.2	Lp
C	1.S	n.c.	
D	2.A		
E	2.B		
F	2.S		
G	3.A		
H	3.B		
J	3.S		
K	4.A	O2.1	Lp
L	4.B	O2.2	Lp
M	4.S	O2.3	
N	5.A	O2.4	F1 +
P	5.B	O2.5	F1 -
R	5.S	O2.8	
S	6.A	O2.6	F2 +
T	6.B	O2.7	F2 -
U	6.S	O2.18	
V	7.A	O2.9	FC cw
W	7.B	O2.11	FC ccw
X	7.S	O2.10	FC com
Y	8.A	O2.12	fbk
Z	8.B	O2.13	fbk
a	8.S	O2.14	
b	9.A	O2.15	Ls
c	9.B	O2.16	Ls
d	9.S	O2.17	

Cable P (vacuum side)

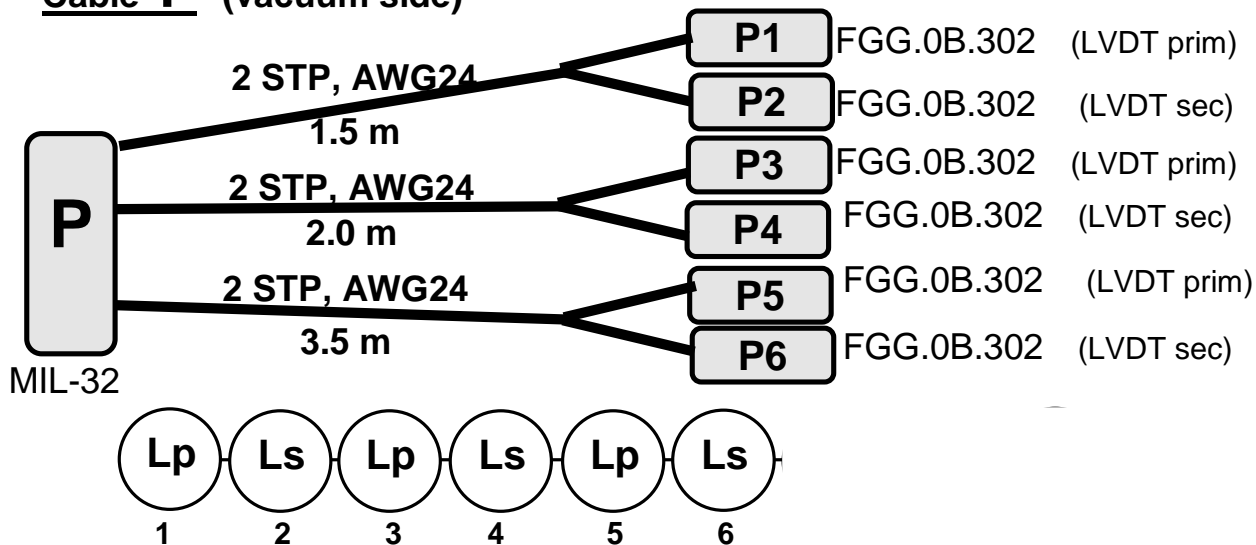

MIL-32 contacts	conductors	LEMO contacts	contact description
A	1.A	P1.1	Lp
B	1.B	P1.2	Lp
C	1.S	n.c.	
D	2.A	P2.3	Ls
E	2.B	P2.4	Ls
F	2.S	n.c.	
G	3.A	P3.5	Lp
H	3.B	P3.6	Lp
J	3.S	n.c.	
K	4.A	P4.7	Ls
L	4.B	P4.8	Ls
M	4.S	n.c.	
N	5.A	P5.1	Lp
P	5.B	P5.2	Lp
R	5.S	n.c.	
S	6.A	P6.1	Ls
T	6.B	P6.2	Ls
U	6.S	n.c.	

Cutting and Stripping phase
Data:
Operator: <i>F.Berni</i>
Bobina di provenienza: <i>spezzoni</i>

Crimping and Labeling phase
Data:
Operator: <i>F.Berni</i>
Tempo impiegato (ore):

Quality Control phase
Date: <i>18aug14</i>
Operator: <i>F.Berni</i>

Cleaning and Storage phase
Data:
Operatore/i:

Notes:
 Diramare opportunamente, considerando che gli LVDT sono disposti a 120 gradi lungo i piedi dell'IP.
 Modificato il 4nov2014 da F.Berni, per rimuovere il cavo dei piezo.
 Per lo schema del vecchio Cavo P vedere la versione v3r1.

Cable Q (vacuum side)

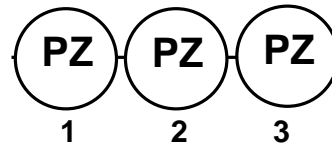
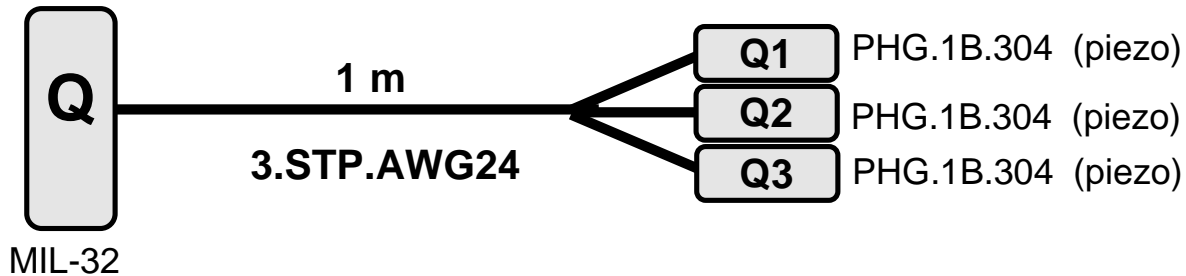

Cutting and Stripping phase
Data: 4nov14
Operator: <i>F.Berni</i>
Bobina di provenienza: <i>spezzoni</i>

Crimping and Labeling phase
Data:
Operator: <i>F.Berni</i>
Tempo impiegato (ore):

Quality Control phase
Dat:
Operator: <i>F.Berni</i>

Cleaning and Storage phase
Data:
Operatore/i:

Notes:
Creato per separare I piezo dagli LVDTs sul cavo P.

MIL-32 contacts	conductors	LEMO contacts	contact description
A			
B			
C			
D			
E			
F			
G			
H			
J			
K			
L			
M			
N			
P			
R			
S			
T			
U			
V	1.A	Q1.1	inner conductor
W	1.B	Q1.2	intermediate shield
X	1.S	Q1.3	outer shield
	n.c.	Q1.4	
Y	2.A	Q2.1	inner conductor
Z	2.B	Q2.2	intermediate shield
a	2.S	Q2.3	outer shield
	n.c.	Q2.4	
b	3.A	Q3.1	inner conductor
c	3.B	Q3.2	intermediate shield
d	3.S	Q3.3	outer shield
	n.c.	Q3.4	

cable R (vacuum side)

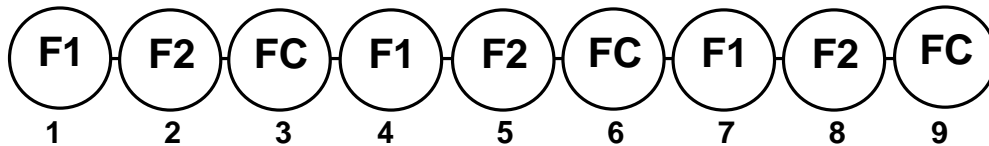
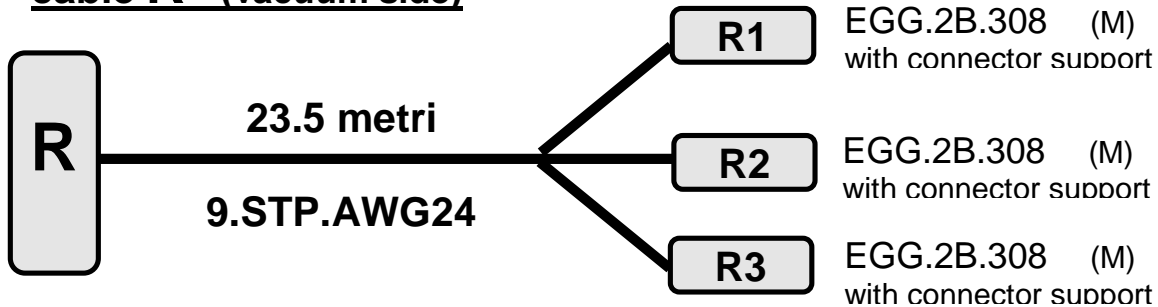

Cutting and Stripping phase
Date:
Operator: <i>F.Berni</i>
Reel:

Crimping and Labeling phase
Date:
Operator: <i>F.Berni</i>
Duration (hours):

Quality Control phase
Date:
Operator:

Cleaning and Storage phase
Date:
Operator:

Notes:
Modificato a Settembre 2014 (scorciato e con Lemo da pannello). Per lo schema del vecchio cavo R vedere la versione v2.
NB: inserire il lemo da pannello nell'apposito clamp a C.
Diramare a <u>20</u> cm

MIL-32 contacts	conductors	LEMO contacts	contact description
A	1.A	R1.1	F1 +
B	1.B	R1.2	F1 -
C	1.S	n.c.	
D	2.A	R1.3	F2 +
E	2.B	R1.4	F2 -
F	2.S	n.c.	
G	3.A	R1.5	FC cw
H	3.B	R1.6	FC ccw
J	3.S	R1.7	FC com
K	4.A	R2.1	F1 +
L	4.B	R2.2	F1 -
M	4.S	n.c.	
N	5.A	R2.3	F2 +
P	5.B	R2.4	F2 -
R	5.S	n.c.	
S	6.A	R2.5	FC cw
T	6.B	R2.6	FC ccw
U	6.S	R2.7	FC com
V	7.A	R3.1	F1 +
W	7.B	R3.2	F1 -
X	7.S	n.c.	
Y	8.A	R3.3	F2 +
Z	8.B	R3.4	F2 -
a	8.S	n.c.	
b	9.A	R3.5	FC cw
c	9.B	R3.6	FC ccw
d	9.S	R3.7	FC com

cable S (vacuum side)

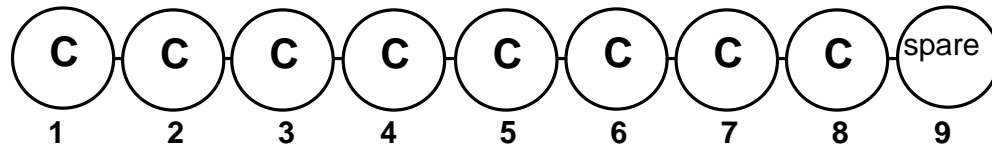
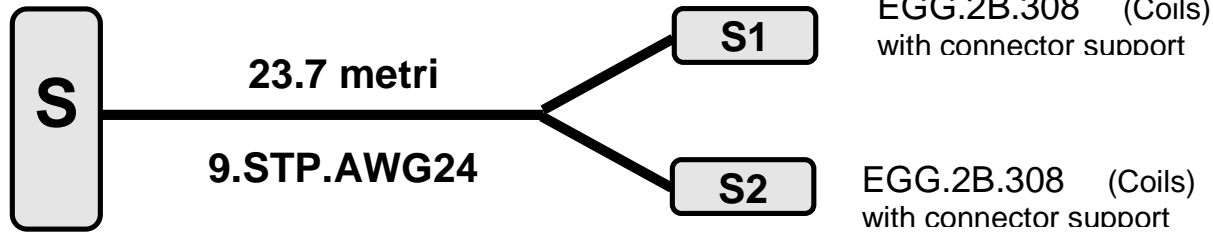

Cutting and Stripping phase
Date:
Operator: <i>F.Berni</i>
Reel: <i>vecchio cavo T</i>

Crimping and Labeling phase
Date:
Operator: : <i>F.Berni</i>
Duration (hours):

Quality Control phase
Date: <i>12aug14</i>
Operator: <i>F.Berni</i>

Cleaning and Storage phase
Date: <i>13aug14</i>
Operator: <i>F.Berni</i>

Notes:
Modificato ad Agosto 2014 (scorciato, messo Lemo da pannello, tolti ponticelli dal Mil-32 , usato vecchio cavo S). Per lo schema del vecchio cavo S vedere la versione v2.
NB: inserire il lemo da pannello nell'apposito clamp a C.
Diramare a <u>20 cm</u> ;

MIL-32 contacts	conductors	LEMO contacts	contact description
A	1.A	S1.1	C +
B	1.B	S1.2	C -
C	1.S	n.c.	
D	2.A	S1.3	C +
E	2.B	S1.4	C -
F	2.S	n.c.	
G	3.A	S1.5	C +
H	3.B	S1.6	C -
J	3.S	n.c.	
K	4.A	S1.7	C +
L	4.B	S1.8	C -
M	4.S	n.c.	
N	5.A	S2.1	C +
P	5.B	S2.2	C -
R	5.S	n.c.	
S	6.A	S2.3	C +
T	6.B	S2.4	C -
U	6.S	n.c.	
V	7.A	S2.5	C +
W	7.B	S2.6	C -
X	7.S	n.c.	
Y	8.A	S2.7	C +
Z	8.B	S2.8	C -
a	8.S	n.c.	
b	9.A		
c	9.B		
d	9.S		

cable T (vacuum side)

In attesa di sopralluogo e disegni

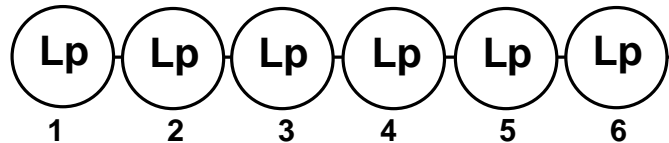
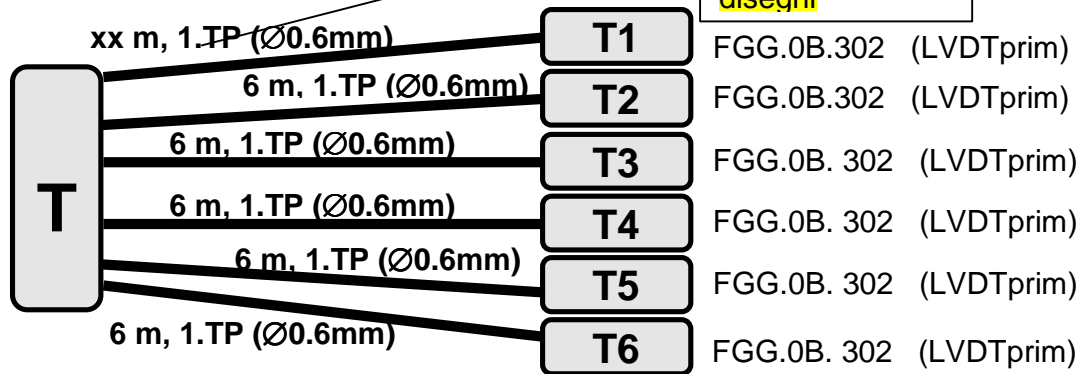

Cutting and Stripping phase
Date:
Operator:
Reel: <i>various spools by RS</i>

Crimping and Labeling phase
Date:
Operator:
Duration (hours):

Quality Control phase
Date:
Operator:

Cleaning and Storage phase
Date:
Operator:

Notes:
 It replaces the old cable T, made with a Gore cable (for the old scheme see version cable_schemes_v2)
 Standard solid wire, with enamel.

MIL-32 contacts	conductors	LEMO contacts	contact description
A	1.A	T1.1	Lp
B	1.B	T1.2	Lp
C	n.c.	n.c.	
D	2.A	T2.1	Lp
E	2.B	T2.2	Lp
F	n.c.	n.c.	
G	3.A	T3.1	Lp
H	3.B	T3.2	Lp
J	n.c.	n.c.	
K	4.A	T4.1	Lp
L	4.B	T4.2	Lp
M	n.c.	n.c.	
N	5.A	T5.1	Lp
P	5.B	T5.2	Lp
R	n.c.	n.c.	
S	6.A	T6.1	Lp
T	6.B	T6.2	Lp
U	n.c.	n.c.	
V			
W			
X			
Y			
Z			
a			
b			
c			
d			

cable V (vacuum side)

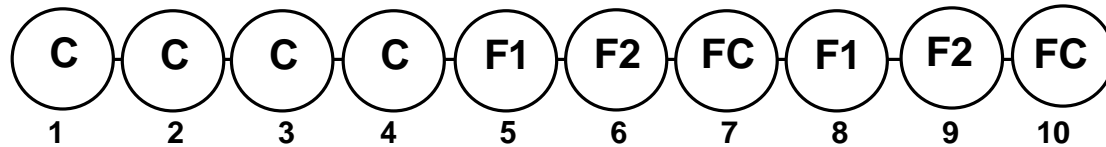
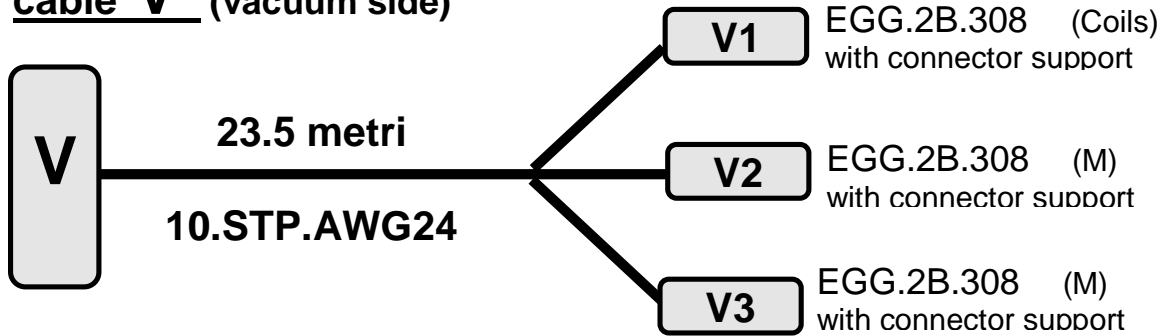

Cutting and Stripping phase
Date:
Operator: <i>F.Berni</i>
Reel: (primo lotto dei cavi di AdV)

Crimping and Labeling phase
Date:
Operator: <i>F.Berni</i>
Duration (hours):

Quality Control phase
Date:
Operator:

Cleaning and Storage phase
Date:
Operator:

Notes:
Rifatto ex-novo a Agosto 2014. Per lo schema del vecchio cavo V vedere la versione v2.
NB: inserire il lemo da pannello nell'apposito clamp a C.
Diramare a 20 cm

MIL-32 contacts	conductors	LEMO contacts	contact description
A	1.A	V1.1	C +
B	1.B	V1.2	C -
C	1.S	n.c.	
D	2.A	V1.3	C +
E	2.B	V1.4	C -
F	2.S	n.c.	
G	3.A	V1.5	C +
H	3.B	V1.6	C -
J	3.S	n.c.	
K	4.A	V1.7	C +
L	4.B	V1.8	C -
M	4.S	n.c.	
N	5.A	V2.1	F1 +
P	5.B	V2.2	F1 -
R	5.S	n.c.	
S	6.A	V2.3	F2 +
T	6.B	V2.4	F2 -
U	6.S	n.c.	
V	7.A	V2.5	FC cw
W	7.B	V2.6	FC ccw
X	7.S	V2.7	FC com
Y	8.A	V3.1	F1 +
Z	8.B	V3.2	F1 -
a	8.S	n.c.	
b	9.A	V3.3	F2 +
c	9.B	V3.4	F2 -
d	9.S	n.c.	
e	10.A	V3.5	FC cw
f	10.B	V3.6	FC ccw
g	10.S	V3.7	FC com

cable W (vacuum side)

In attesa di sopralluogo

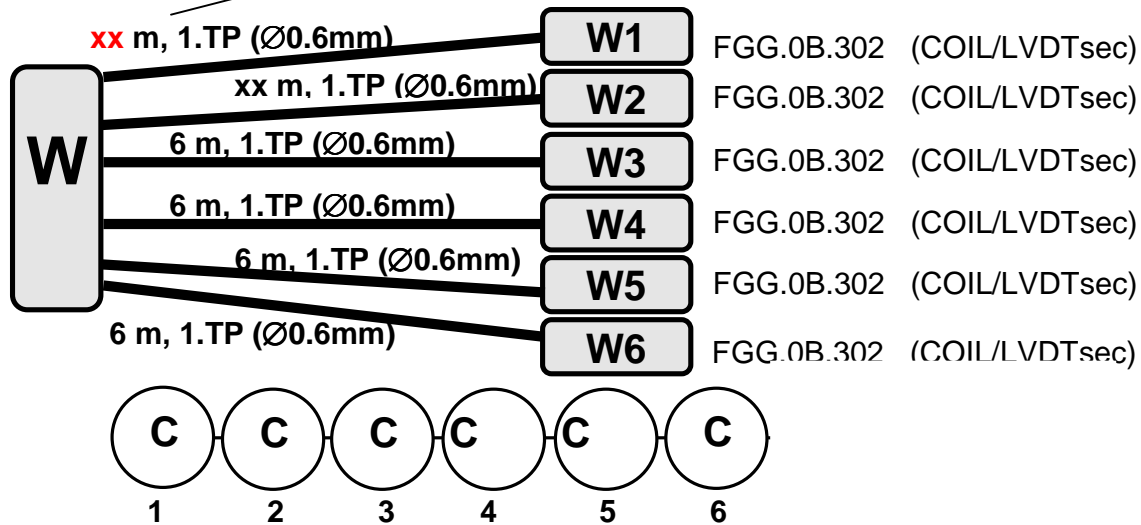

Cutting and Stripping phase
Date:
Operator: <i>F.Berni</i>
Reel: #2 by MWS, AWG 24 HML

Crimping and Labeling phase
Date:
Operator: <i>F.Berni</i>
Duration (hours):

Quality Control phase
Date:
Operator: <i>Berni</i>

Cleaning and Storage phase
Date:
Operator: <i>Berni</i>

Notes:
 It replaces the old cable W, that was made with a Gore cable (for the old scheme see version cable_schemes_v2).
 The new one is standard solid wire, with Pyre enamel, double (heavy) insulation.

MIL-32 contacts	conductors	LEMO contacts	contact description
A	1.A	W1.1	C +
B	1.B	W1.2	C -
C	n.c.	n.c.	
D	2.A	W2.1	C +
E	2.B	W2.2	C -
F	n.c.	n.c.	
G	3.A	W3.1	C +
H	3.B	W3.2	C -
J	n.c.	n.c.	
K	4.A	W4.1	C +
L	4.B	W4.2	C -
M	n.c.	n.c.	
N	5.A	W5.1	C +
P	5.B	W5.2	C -
R	n.c.	n.c.	
S	6.A	W6.1	C +
T	6.B	W6.2	C -
U	n.c.	n.c.	
V			
W			
X			
Y			
Z			
a			
b			
c			
d			

cable Z (vacuum side)

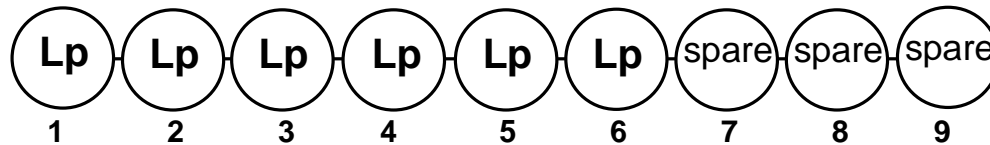
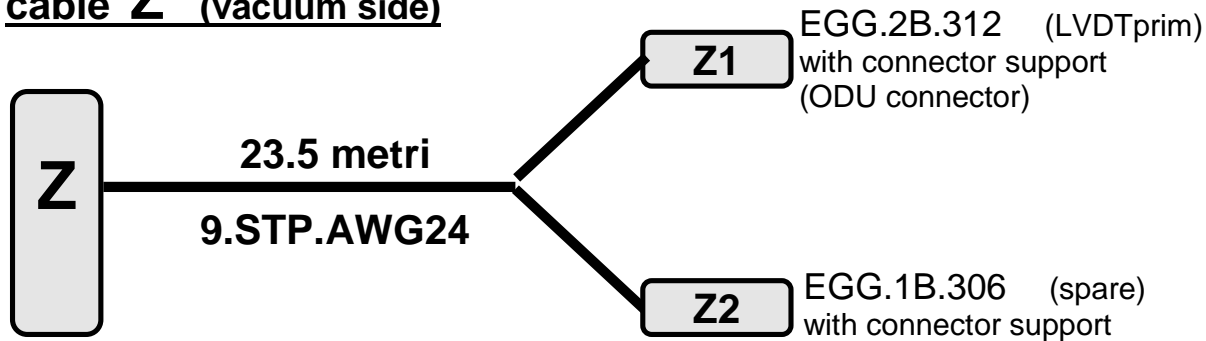

Cutting and Stripping phase		Crimping and Labeling phase	
Date:		Date:	
Operator:		Operator:	
Reel: <i>vecchio cavo F</i>		Duration (hours):	
Quality Control phase		Cleaning and Storage phase	
Date:		Date:	
Operator:		Operator:	
Notes:			
Nuovo, creato per AdV. Per collegare i primari degli attuatori/LVDT del F#7 in caso di installazione primari sul body del F#7.			

MIL-32 contacts	conductors	ODU / LEMO contacts	contact description
A	1.A	Z1.1	Lp
B	1.B	Z1.2	Lp
C	1.S	n.c.	
D	2.A	Z1.3	Lp
E	2.B	Z1.4	Lp
F	2.S	n.c.	
G	3.A	Z1.5	Lp
H	3.B	Z1.6	Lp
J	3.S	n.c.	
K	4.A	Z1.7	Lp
L	4.B	Z1.8	Lp
M	4.S	n.c.	
N	5.A	Z1.9	Lp
P	5.B	Z1.10	Lp
R	5.S	n.c.	
S	6.A	Z1.11	Lp
T	6.B	Z1.12	Lp
U	6.S	n.c.	
V	7.A	Z2.1	spare
W	7.B	Z2.2	spare
X	7.S	n.c.	
Y	8.A	Z2.3	spare
Z	8.B	Z2.4	spare
a	8.S	n.c.	
b	9.A	Z2.5	spare
c	9.B	Z2.6	spare
d	9.S	n.c.	