

Added a 15V zener between pin 1 (Cathode) & 3 (Anode) of U25 in order to avoid a latch-up problem at startup
 (Use + holes of C68 and C70)

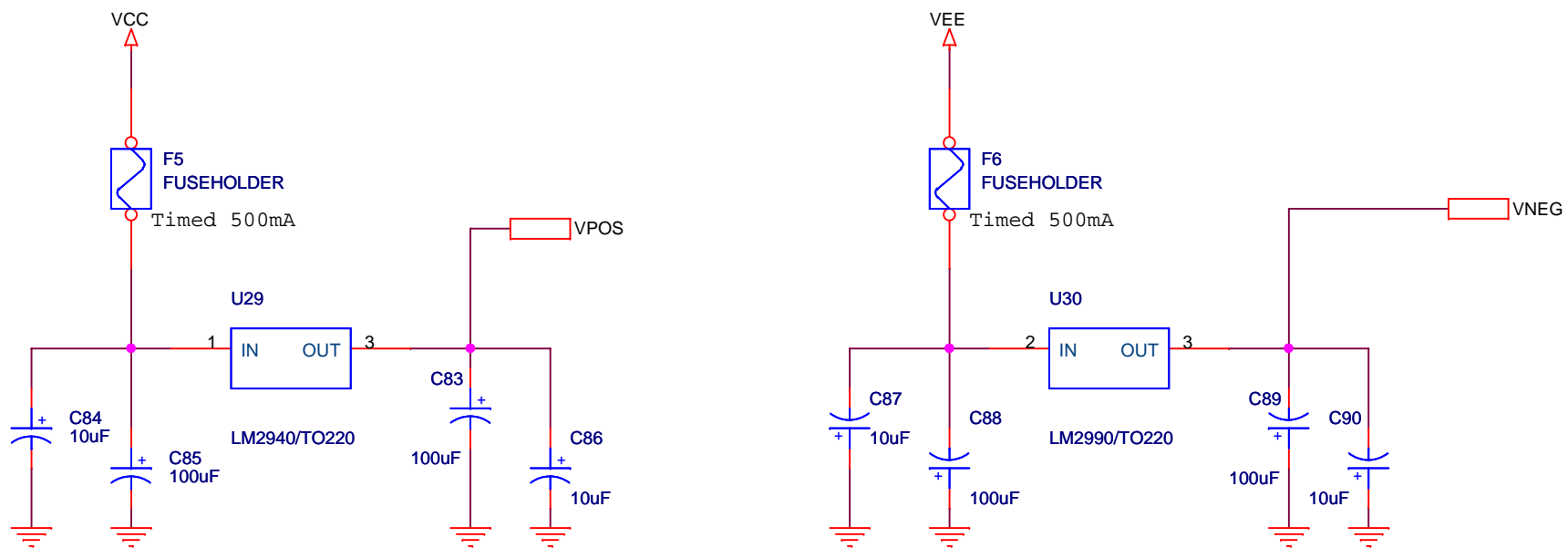

C68, C67, C70, C71, C73, C74 not placed

Title		
<Title>		
Size	Document Number	Rev
A	<Doc>	<RevCode>
Date:	Friday, October 03, 2008	Sheet 8 of 9